

SPECIFICATION SHEET NO.	T0114- SMAJ15CA00S0XM	
ORIGINAL MFG/PART NO.	 MDD Diodes/SMAJ15CA	
NEXTGEN PART CODE	SMAJ15CA00S0XM	Indicate This Code For RFQ /Order
DATE	Jan. 14, 2026	
REVISION	A6	Updated With Most Recent Data
DESCRIPTION AND MAIN PARAMETRICS	<p>SMD Transient Voltage Suppressor (TVs) Diodes, SMAJ Series Case SMA/DO-214AC, 2 Pads, Bidirectional Type, Reverse Stand-off Voltage 15V, Peak Pulse Power: 400 Watts, Peak Pulse Current: 16.4A Max. Operating Junction Temp. Range -65°C ~+150°C Package in Tape/Reel, 5000pcs/Reel RoHS/RoHS III compliant, RoHS Annex III lead Exemption (Exempt per RoHS EU 2015/863) and Halogen Free (HF)</p>	
CUSTOMER		
CUSTOMER PART NUMBER		
CROSS REF. PART NUMBER		
MEMO		

VENDOR APPROVE			
Issued/Checked/Approved			
Effective Date: Jan. 14, 2026			

CUSTOMER APPROVE	
Date:	

MAIN FEATURE

- The Plastic Package Carries Underwriters Laboratory Flammability Classification 94V-0
- Low Profile Package
- Built-in Strain Relief
- High Temperature Soldering Guaranteed: 260°C/ 10 Seconds At Terminals
- Glass Passivated Chip Junction
- Low Inductance
- 5% VBR Voltage Tolerance
- Excellent Clamping Capability
- 400W Peak Pulse Power Capability At 10/1000µs Waveform
- Repetition Rate (Duty Cycle): 0.01%
- Fast Response Time
- Repetition Rate (Duty Cycle): 0.01%
- Typical I_R Less Than 1µA Above 10V
- Cross Competitors Parts and More.
- RoHS/RoHS III Compliant, RoHS Annex III Lead Exemption (Exempt per RoHS EU 2015/863)



*Image shown is a representation only.
Exact specifications should be obtained
from the product dimension.*



APPLICATION

- I/O Interface
- AC/DC Power Supply
- Low Frequency Signal Transmission Line (RS232, RS485, etc.)

ELECTRICAL CHARACTERISTICS

- See Page 5 ~Page 11 For Different Part Code
- All Parameters are Subject To NextGen Components' Final Confirmation

HOW TO ORDER

- Please Follow Up Part Code Guide And Indicate NextGen Part Code SMAJ15CA00S0XM For RFQ and Order.

RFQ
[Request For Quotation](#)

PART CODE GUIDE

CODE	NAME	KEY SPECIFICATION OPTION
SMAJ	Product Series Code	SMD Transient Voltage Suppressors (TVs) Diodes, Case SMA/DO-214AC, 2 Pads
15CA	Mode code	15CA: Reverse Stand-Off Voltage 15V, Bidirectional Polarity Type
00S0	Internal Control Code	Letter or Digits (A~Z, a~z or 0~9)
XM	Marking Code	Marking “XM”
XX	Special/Custom Parameters Code	Letter or Digits (A~Z, a~z or 0~9) for Special Parametric; Blank: N/A

DIMENSION- Unit: Inch/mm, Case SMA/DO-214AC Outline

Top View

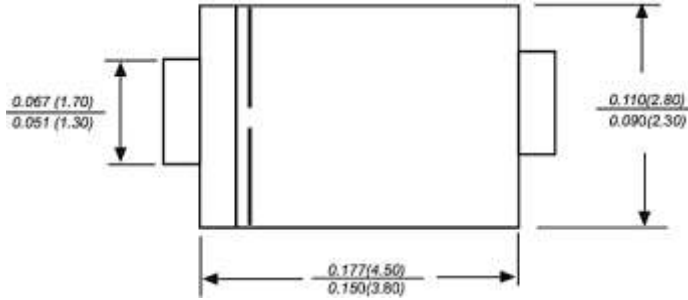

Side View

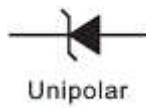
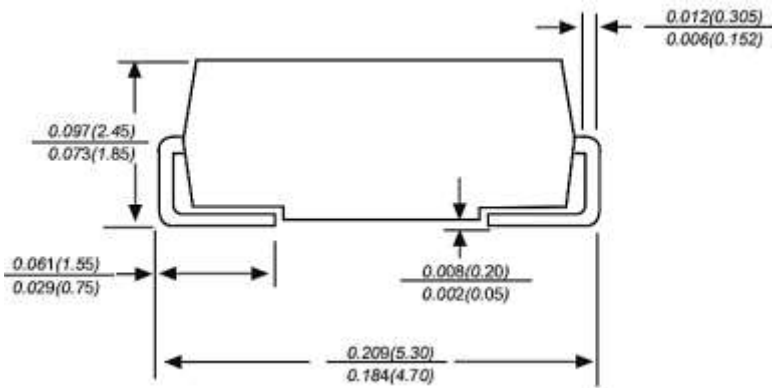

Recommend Pad Layout



SYMBOL	A	B	C	D	E
Unit (Inch)	0.066	0.060	0.155	0.095	0.215
Unit (mm)	1.680	1.520	3.930	2.41	5.45

MECHANICAL DATA

CASE	TERMINALS	POLARITY	MOUNTING POSITION	MARKING	WEIGHT PER PIECE
JEDEC SMA/DO-214AC Molded Plastic Body	Solderable per MIL-STD- 750, Method 2026	Polarity Symbol Marking On Body	Any	See Marking Code List	0.070 Grams

MAX. RATING & CHARACTERISTICS - Ratings At 25°C Ambient Temperature Unless Otherwise Specified.

PARAMETER	SYMBOLS	VALUE	UNITS
Peak Pulse Power Dissipation At 10/1000µs Waveform (Note 1, Note 2, Fig. 1)	PPPM	400 Min.	W
Peak Pulse Current On 10/1000 Us Waveform (Note 1, Fig. 3)	I _{PPM}	See Page 6~page 11	A
Steady State Power Dissipation At TA=50°C (Fig. 5)	P _{M(AV)}	3.3	W
Peak Forward Surge Current, 8.3ms Single Half Sine-wave Superimposed On Rated Load (JEDEC Method) (Note 3, Fig. 6)	I _{FSM}	40	A
Operating Junction And Storage Temperature Range.	T _J , T _{stg}	-65 ~ +150	°C
Typical Thermal Resistance Junction To Lead	R _{θJL}	30	°C/W
Typical Thermal Resistance Junction To Ambient	R _{θJA}	120	°C/W

Note

1. Non-repetitive current pulse, per Fig 3 and derated above TA=25 °C per Fig 2
2. Mounted on 5.0*5.0mm (0.03mm Thickness) copper pads to each terminal
3. 8.3ms single half sinewave or equivalent square wave, duty cycle=4 pulsed per minute Max.

UNIDIRECTIONAL TYPE- ELECTRICAL CHARACTERISTICS - Ta = 25°C

Part Code	Reverse Stand-off Voltage	Breakdown Voltage		Test Current	Reverse Leakage Max.	Max. Clamp Voltage	Peak Pulse Current	Marking Code
		VBR @ IT						
	VRWM	Min	Max	IT	IR @ VRWM	Vc @ IPP	IPP	
V	V	V	mA	µA	V	A		
SMAJ050A00S0AE	5	6.4	7	10	800	9.2	43.5	AE
SMAJ060A00S0AG	6	6.67	7.37	10	800	10.3	38.8	AG
SMAJ065A00S0AK	6.5	7.22	7.98	10	500	11.2	35.7	AK
SMAJ070A00S0AM	7	7.78	8.6	10	200	12	33.3	AM
SMAJ075A00S0AP	7.5	8.33	9.2	1	100	12.9	31	AP
SMAJ080A00S0AR	8	8.89	9.83	1	50	13.6	29.4	AR
SMAJ085A00S0AT	8.5	9.44	10.4	1	20	14.4	27.8	AT
SMAJ090A00S0AV	9	10	11.1	1	10	15.4	26	AV
SMAJ10A000S0AX	10	11.1	12.3	1	5	17	23.5	AX
SMAJ11A000S0AZ	11	12.2	13.5	1	1	18.2	22	AZ
SMAJ12A000S0BE	12	13.3	14.7	1	1	19.9	20.1	BE
SMAJ13A000S0BG	13	14.4	15.9	1	1	21.5	18.6	BG
SMAJ14A000S0BK	14	15.6	17.2	1	1	23.2	17.2	BK
SMAJ15A000S0BM	15	16.7	18.5	1	1	24.4	16.4	BM
SMAJ16A000S0BP	16	17.8	19.7	1	1	26	15.4	BP
SMAJ17A000S0BR	17	18.9	20.9	1	1	27.6	14.5	BR
SMAJ18A000S0BT	18	20	22.1	1	1	29.2	13.7	BT
SMAJ20A000S0BV	20	22.2	24.5	1	1	32.4	12.3	BV
SMAJ22A000S0BX	22	24.4	26.9	1	1	35.5	11.3	BX
SMAJ24A000S0BZ	24	26.7	29.5	1	1	38.9	10.3	BZ

UNIDIRECTIONAL TYPE- ELECTRICAL CHARACTERISTICS - Ta = 25°C

Part Code	Reverse Stand-off Voltage	Breakdown Voltage		Test Current	Reverse Leakage Max.	Max. Clamp Voltage	Peak Pulse Current	Marking Code
		VBR @ IT						
	VRWM	Min	Max	IT	IR @ VRWM	Vc @ IPP	IPP	
V	V	V	mA	µA	V	A		
SMAJ26A000S0CE	26	28.9	31.9	1	1	42.1	9.5	CE
SMAJ28A000S0CG	28	31.1	34.4	1	1	45.4	8.8	CG
SMAJ30A000S0CK	30	33.3	36.8	1	1	48.4	8.3	CK
SMAJ33A000S0CM	33	36.7	40.6	1	1	53.3	7.5	CM
SMAJ36A000S0CP	36	40	44.2	1	1	58.1	6.9	CP
SMAJ40A000S0CR	40	44.4	49.1	1	1	64.5	6.2	CR
SMAJ43A000S0CT	43	47.8	52.8	1	1	69.4	5.8	CT
SMAJ45A000S0CV	45	50	55.3	1	1	72.7	5.5	CV
SMAJ48A000S0CX	48	53.3	58.9	1	1	77.4	5.2	CX
SMAJ51A000S0CZ	51	56.7	62.7	1	1	82.4	4.9	CZ
SMAJ54A000S0RE	54	60	66.3	1	1	87.1	4.6	RE
SMAJ58A000S0RG	58	64.4	71.2	1	1	93.6	4.3	RG
SMAJ60A000S0RK	60	66.7	73.7	1	1	96.8	4.1	RK
SMAJ64A000S0RM	64	71.1	78.6	1	1	103	3.9	RM
SMAJ70A000S0RP	70	77.8	86	1	1	113	3.5	RP
SMAJ75A000S0RR	75	83.3	92.1	1	1	121	3.3	RR
SMAJ78A000S0RT	78	86.7	95.8	1	1	126	3.2	RT
SMAJ85A000S0RV	85	94.4	104	1	1	137	2.9	RV
SMAJ90A000S0RX	90	100	111	1	1	146	2.7	RX
SMAJ100A00S0RZ	100	111	123	1	1	162	2.5	RZ

UNIDIRECTIONAL TYPE- ELECTRICAL CHARACTERISTICS - Ta = 25°C

Part Code	Reverse Stand-off Voltage	Breakdown Voltage		Test Current	Reverse Leakage Max.	Max. Clamp Voltage	Peak Pulse Current	Marking Code
		VBR @ IT						
	VRWM	Min	Max	IT	IR @ VRWM	Vc @ IPP	IPP	
	V	V	V	mA	µA	V	A	
SMAJ110A00S0SE	110	122	135	1	1	177	2.3	SE
SMAJ120A00S0SG	120	133	147	1	1	193	2.1	SG
SMAJ130A00S0SK	130	144	159	1	1	209	1.9	SK
SMAJ150A00S0SM	150	167	185	1	1	243	1.6	SM
SMAJ160A00S0SP	160	178	197	1	1	259	1.5	SP
SMAJ170A00S0SR	170	189	209	1	1	275	1.5	SR
SMAJ180A00S0ST	180	201	222	1	1	292	1.4	ST
SMAJ190A00S0SU	190	211	232	1	1	308	1.3	SU
SMAJ200A00S0SV	200	224	247	1	1	324	1.2	SV
SMAJ210A00S0SW	210	237	263	1	1	340	1.2	SW
SMAJ220A00S0GE	220	246	272	1	1	356	1.1	GE
SMAJ250A00S0SZ	250	279	309	1	1	405	1.0	SZ
SMAJ300A00S0TE	300	335	371	1	1	486	0.8	TE
SMAJ350A00S0TG	350	391	432	1	1	567	0.7	TG
SMAJ400A00S0TK	400	447	494	1	1	648	0.6	TK
SMAJ440A00S0TM	440	492	543	1	1	713	0.6	TM

BIDIRECTIONAL TYPE- ELECTRICAL CHARACTERISTICS - Ta = 25°C

Part Code	Reverse Stand-off Voltage	Breakdown Voltage		Test Current	Reverse Leakage Max.	Max. Clamp Voltage	Peak Pulse Current	Marking Code
		VBR @ IT						
	VRWM	Min	Max	IT	IR @ VRWM	Vc @ IPP	IPP	
V	V	V	mA	µA	V	A		
SMAJ050CA0S0WE	5	6.4	7	10	800	9.2	43.5	WE
SMAJ060CA0S0WG	6	6.67	7.37	10	800	10.3	38.8	WG
SMAJ065CA0S0WK	6.5	7.22	7.98	10	500	11.2	35.7	WK
SMAJ070CA0S0WM	7	7.78	8.6	10	200	12	33.3	WM
SMAJ075CA0S0WP	7.5	8.33	9.2	1	100	12.9	31	WP
SMAJ080CA0S0WR	8	8.89	9.83	1	50	13.6	29.4	WR
SMAJ085CA0S0WT	8.5	9.44	10.4	1	20	14.4	27.8	WT
SMAJ090CA0S0WV	9	10	11.1	1	10	15.4	26	WV
SMAJ10CA00S0WX	10	11.1	12.3	1	5	17	23.5	WX
SMAJ11CA00S0WZ	11	12.2	13.5	1	1	18.2	22	WZ
SMAJ12CA00S0XE	12	13.3	14.7	1	1	19.9	20.1	XE
SMAJ13CA00S0XG	13	14.4	15.9	1	1	21.5	18.6	XG
SMAJ14CA00S0XK	14	15.6	17.2	1	1	23.2	17.2	XK
SMAJ15CA00S0XM	15	16.7	18.5	1	1	24.4	16.4	XM
SMAJ16CA00S0XP	16	17.8	19.7	1	1	26	15.4	XP
SMAJ17CA00S0XR	17	18.9	20.9	1	1	27.6	14.5	XR
SMAJ18CA00S0XT	18	20	22.1	1	1	29.2	13.7	XT
SMAJ20CA00S0XV	20	22.2	24.5	1	1	32.4	12.3	XV
SMAJ22CA00S0XX	22	24.4	26.9	1	1	35.5	11.3	XX
SMAJ24CA00S0XZ	24	26.7	29.5	1	1	38.9	10.3	XZ

BIDIRECTIONAL TYPE- ELECTRICAL CHARACTERISTICS - Ta = 25°C

Part Code	Reverse Stand-off Voltage	Breakdown Voltage		Test Current	Reverse Leakage Max.	Max. Clamp Voltage	Peak Pulse Current	Marking Code
		VBR @ IT						
	VRWM	Min	Max	IT	IR @ VRWM	Vc @ IPP	IPP	
V	V	V	mA	µA	V	A		
SMAJ26CA00S0YE	26	28.9	31.9	1	1	42.1	9.5	YE
SMAJ28CA00S0YG	28	31.1	34.4	1	1	45.4	8.8	YG
SMAJ30CA00S0YK	30	33.3	36.8	1	1	48.4	8.3	YK
SMAJ33CA00S0YM	33	36.7	40.6	1	1	53.3	7.5	YM
SMAJ36CA00S0YP	36	40	44.2	1	1	58.1	6.9	YP
SMAJ40CA00S0YR	40	44.4	49.1	1	1	64.5	6.2	YR
SMAJ43CA00S0YT	43	47.8	52.8	1	1	69.4	5.8	YT
SMAJ45CA00S0YV	45	50	55.3	1	1	72.7	5.5	YV
SMAJ48CA00S0YX	48	53.3	58.9	1	1	77.4	5.2	YX
SMAJ51CA00S0YZ	51	56.7	62.7	1	1	82.4	4.9	YZ
SMAJ54CA00S0ZE	54	60	66.3	1	1	87.1	4.6	ZE
SMAJ58CA00S0ZG	58	64.4	71.2	1	1	93.6	4.3	ZG
SMAJ60CA00S0ZK	60	66.7	73.7	1	1	96.8	4.1	ZK
SMAJ64CA00S0ZM	64	71.1	78.6	1	1	103	3.9	ZM
SMAJ70CA00S0ZP	70	77.8	86	1	1	113	3.5	ZP
SMAJ75CA00S0ZR	75	83.3	92.1	1	1	121	3.3	ZR
SMAJ78CA00S0ZT	78	86.7	95.8	1	1	126	3.2	ZT
SMAJ85CA00S0ZV	85	94.4	104	1	1	137	2.9	ZV
SMAJ90CA00S0ZX	90	100	111	1	1	146	2.7	ZX
SMAJ100CA00S0ZZ	100	111	123	1	1	162	2.5	ZZ

BIDIRECTIONAL TYPE- ELECTRICAL CHARACTERISTICS - Ta = 25°C

Part Code	Reverse Stand-off Voltage	Breakdown Voltage		Test Current	Reverse Leakage Max.	Max. Clamp Voltage	Peak Pulse Current	Marking Code
		VBR @ IT						
	VRWM	Min	Max	IT	IR @ VRWM	Vc @ IPP	IPP	
V	V	V	mA	µA	V	A		
SMAJ110CA0S0VE	110	122	135	1	1	177	2.3	VE
SMAJ120CA0S0VG	120	133	147	1	1	193	2.1	VG
SMAJ130CA0S0VK	130	144	159	1	1	209	1.9	VK
SMAJ150CA0S0VM	150	167	185	1	1	243	1.6	VM
SMAJ160CA0S0VP	160	178	197	1	1	259	1.5	VP
SMAJ170CA0S0VR	170	189	209	1	1	275	1.5	VR
SMAJ180CA0S0VT	180	201	222	1	1	292	1.4	VT
SMAJ190CA0S0YU	190	211	232	1	1	308	1.3	YU
SMAJ200CA0S0VV	200	224	247	1	1	324	1.2	VV
SMAJ210CA0S0YW	210	237	263	1	1	340	1.2	YW
SMAJ220CA0S0VX	220	246	272	1	1	356	1.1	VX
SMAJ250CA0S0VZ	250	279	309	1	1	405	1.0	VZ
SMAJ300CA0S0UE	300	335	371	1	1	486	0.8	UE
SMAJ350CA0S0UG	350	391	432	1	1	567	0.7	UG
SMAJ400CA0S0UK	400	447	494	1	1	648	0.6	UK
SMAJ440CA0S0UM	440	492	543	1	1	713	0.6	UM

Note: For Bidirectional Type Having Vrwm Of 10V And Less, The Ir Limit Is Double.

RATINGS AND CHARACTERISTICS CURVES- FOR REFERENCE ONLY, $T_A=25^\circ\text{C}$ UNLESS OTHERWISE SPECIFIED.

Figure 1. Peak Pulse Power Rating Curve

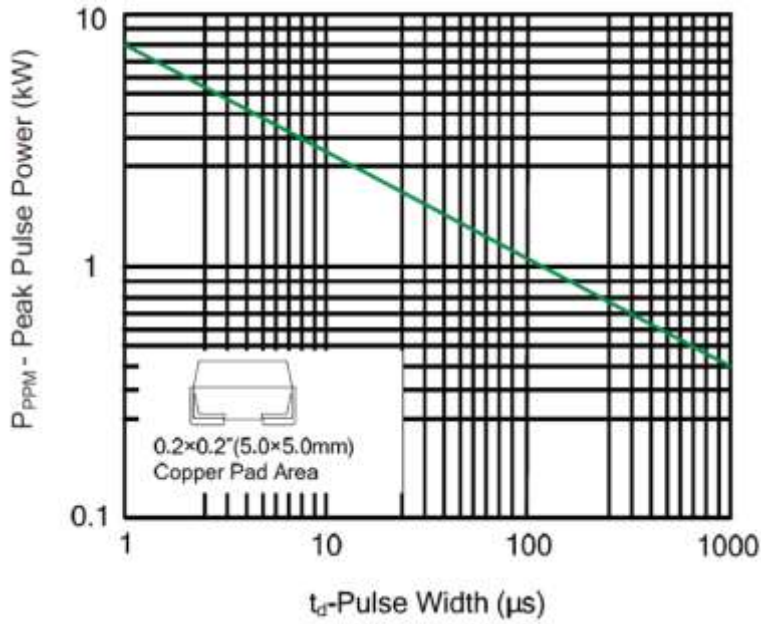

Figure 2. Pulse Derating Curve



RATINGS AND CHARACTERISTICS CURVES- FOR REFERENCE ONLY, $T_A=25^\circ\text{C}$ UNLESS OTHERWISE SPECIFIED.

Figure 3. Pulse Waveform

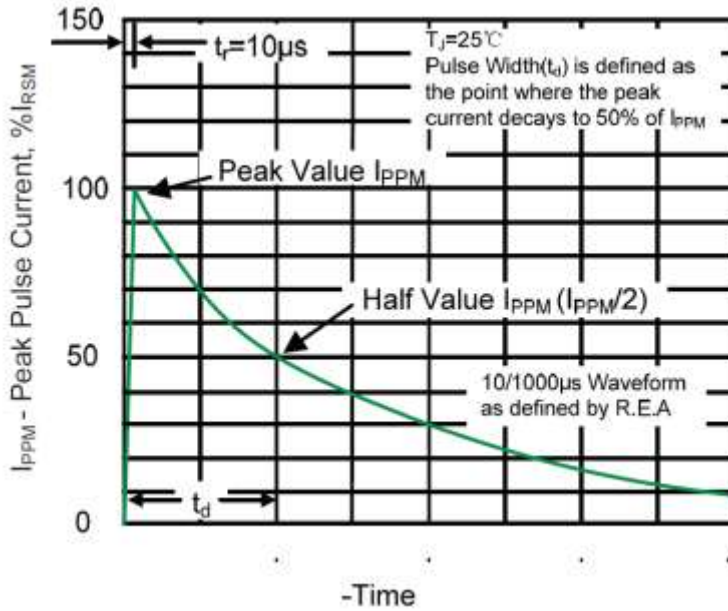

Figure 4. Typical Junction Capacitance



RATINGS AND CHARACTERISTICS CURVES- FOR REFERENCE ONLY, $T_A=25^\circ\text{C}$ UNLESS OTHERWISE SPECIFIED.

Figure 5. Steady State Power Dissipation Derating curve

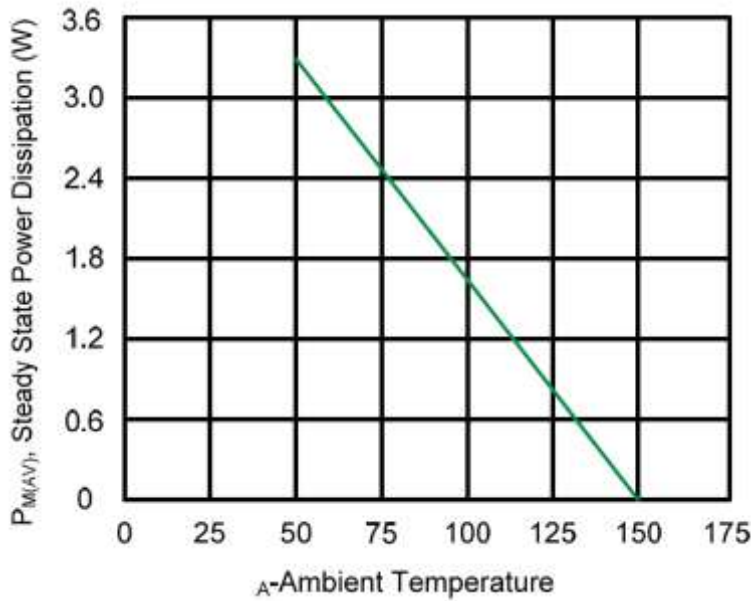
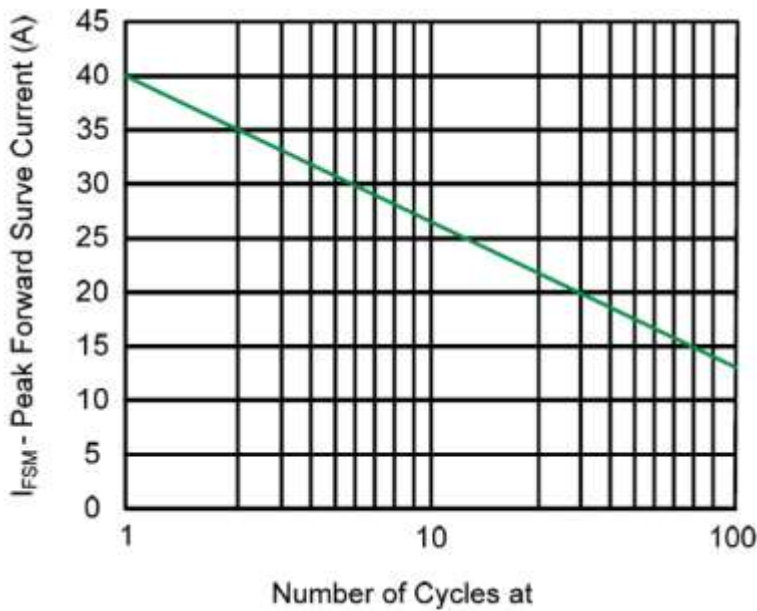
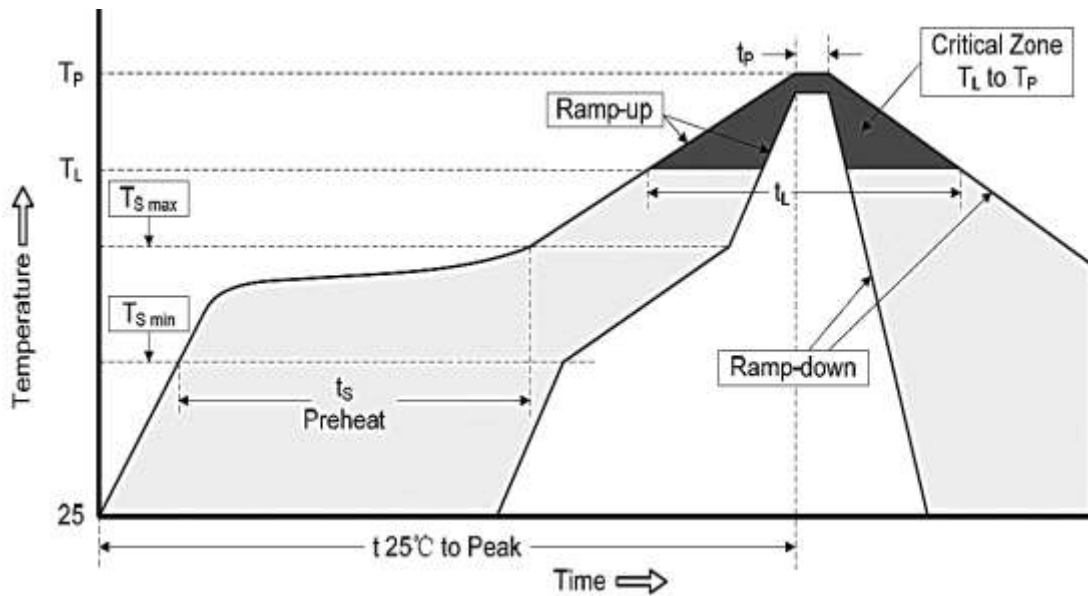

Figure 6. Maximum Non-Repetitive Forward Surge Current Uni-Directional Only



RECOMMENDED SOLDERING PARAMETERS – FOR REFERENCE ONLY



PROFILE FEATURE		PB-FREE ASSEMBLY
Average Ramp-up Rate (T_L to T_p)		3°C/second Max
Preheat	Temperature Min (T_s Min.)	150°C
	Temperature Max (T_s Max.)	200°C
	Time (t_s Min. to t_s Max.)	60 ~ 180 seconds
T_s max to T_L Ramp-up Rate		3°C/second Max
Time maintained above	Temperature (T_L)	217°C
	Time (t_L)	60 ~ 150 seconds
Peak/Classification Temperature (T_p)		260 °C
Time within 5°C of actual Peak Temperature (t_p)		20 ~ 40 seconds
Ramp-down Rate		6 °C /Second Max.
Time 25 °C to Peak Temperature		8 Minutes Max.
Suggest reflow times		3 Times Max.

TAPE/REEL - Unit: mm, All Devices are packed in accordance with EIA standard RS-481-A and specifications

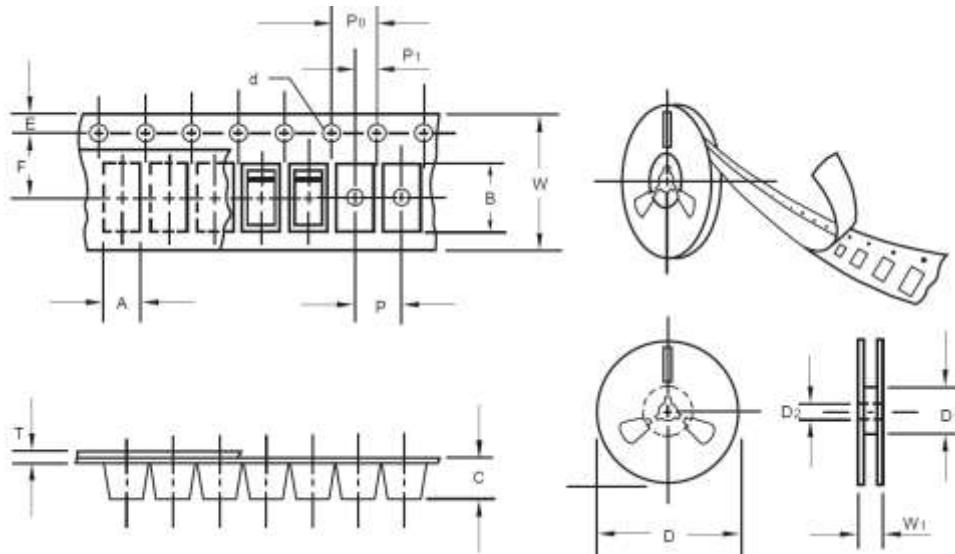

ITEM	SYMBOL	TOLERANCE	SMA/DO-214AC
Carrier width	A	0.1	2.80
Carrier Length	B	0.1	5.33
Carrier Depth	C	0.1	2.36
Sprocket hole	d	0.05	1.50
13" Reel outside diameter	D	2.0	330.0
13" Reel inner diameter	D1	Min.	50.0Min.
Feed hole diameter	D2	0.5	13.00
Sprocket hole position	E	0.1	1.75
Punch hole position	F	0.1	5.50
Punch hole pitch	P	0.1	4.00
Sprocket hole pitch	P0	0.1	4.00
Embossment center	P1	0.1	2.0
Overall tape thickness	T	0.1	0.28
Tape width	W	0.3	12.00
Reel width	W1	1.0	18.0
Qty./Reel (pcs)	5000		

IMPORTANT NOTES AND DISCLAIMER

1. **ROHS COMPLIANCE:** The levels of RoHS restricted materials in this product are below the maximum concentration values (also referred to as the threshold limits) permitted for such substances, or are used in an exempted application, in accordance with EU RoHS Directive (EU) 2015/863 EC (RoHS3). RoHS Test Report for this product can be obtained at Download Center.
2. **REACH COMPLIANCE:** REACH substances of high concern (SVHCs) information is available for this product. Since the European Chemical Agency (ECHA) has published notice of their intent to frequently revise the SVHC listing for the foreseeable future, REACH Test Report for this product can be obtained at Download Center.
3. All Product parametric performance is indicated in the Electrical Characteristics for the listed herein test conditions, unless otherwise noted. Product performance may not be indicated by the Electrical Characteristics if operated under different conditions.
4. NextGen Component, Inc (*NextGen*) reserves the right to make changes to this document and its products and specifications at any time without notice. Customers should obtain and confirm the latest product information and specifications before final design, purchase or use.
5. *NextGen* makes no warranty, representation or guarantee regarding the suitability of its products for any particular purpose, not does *NextGen* assume any liability for application assistance or customer product design.
6. *NextGen* does not warrant or accept any liability with products which are purchased or used for any unintended or unauthorized application. No license is granted by implication or otherwise under any intellectual property rights of NextGen.
7. *NextGen* products are not authorized for use as critical components in life support devices or systems without express written approval by *NextGen*.
8. *NextGen* requires that customers first obtain an RMA (Returned Merchandise Authorization) number prior to returning any products. Returns must be made within 30 days of the date of invoice, be in the original packaging, unused and like-new condition. At the time of quoting or purchasing, a product may say that it is Non-Cancelable/ Non-Returnable (NCNR). These products are not returnable and not refundable.