





| | | |
|----------------------------------|---|---|
| SPECIFICATION SHEET NO. | T0114- SMAJ85CA00S0ZV | |
| ORIGINAL MFG/PART NO. |  MDD Diodes/SMAJ85CA | |
| NEXTGEN PART CODE | SMAJ85CA00S0ZV | Indicate This Code For RFQ /Order |
| DATE | Jan. 14, 2026 | |
| REVISION | A6 | Updated With Most Recent Data |
| DESCRIPTION AND MAIN PARAMETRICS | <p>SMD Transient Voltage Suppressor (TVs) Diodes, SMAJ Series Case SMA/DO-214AC, 2 Pads, Bidirectional Type, Reverse Stand-off Voltage 85V, Peak Pulse Power: 400 Watts, Peak Pulse Current: 2.9A Max. Operating Junction Temp. Range -65°C ~+150°C Package in Tape/Reel, 5000pcs/Reel RoHS/RoHS III compliant, RoHS Annex III lead Exemption (Exempt per RoHS EU 2015/863) and Halogen Free (HF)</p> | |
| CUSTOMER | | |
| CUSTOMER PART NUMBER | | |
| CROSS REF. PART NUMBER | | |
| MEMO | | |

| | | | |
|-------------------------------|---|--|---|
| VENDOR APPROVE | | | |
| Issued/Checked/Approved |  |  |  |
| Effective Date: Jan. 14, 2026 | | | |

| | |
|------------------|--|
| CUSTOMER APPROVE | |
| | |
| Date: | |

MAIN FEATURE

- The Plastic Package Carries Underwriters Laboratory Flammability Classification 94V-0
- Low Profile Package
- Built-in Strain Relief
- High Temperature Soldering Guaranteed: 260°C/ 10 Seconds At Terminals
- Glass Passivated Chip Junction
- Low Inductance
- 5% VBR Voltage Tolerance
- Excellent Clamping Capability
- 400W Peak Pulse Power Capability At 10/1000 μ s Waveform
- Repetition Rate (Duty Cycle): 0.01%
- Fast Response Time
- Repetition Rate (Duty Cycle): 0.01%
- Typical I_R Less Than 1 μ A Above 10V
- Cross Competitors Parts and More.
- RoHS/RoHS III Compliant, RoHS Annex III Lead Exemption (Exempt per RoHS EU 2015/863)



*Image shown is a representation only.
Exact specifications should be obtained
from the product dimension.*



APPLICATION

- I/O Interface
- AC/DC Power Supply
- Low Frequency Signal Transmission Line (RS232, RS485, etc.)

ELECTRICAL CHARACTERISTICS

- See Page 5 ~Page 11 For Different Part Code
- All Parameters are Subject To NextGen Components' Final Confirmation

HOW TO ORDER

- Please Follow Up Part Code Guide And Indicate NextGen Part Code SMAJ85CA00S0ZV For RFQ and Order.

RFQ
[Request For Quotation](#)

PART CODE GUIDE

| CODE | NAME | KEY SPECIFICATION OPTION |
|------|--------------------------------|---|
| SMAJ | Product Series Code | SMD Transient Voltage Suppressors (TVs) Diodes, Case SMA/DO-214AC, 2 Pads |
| 85CA | Mode code | 85CA: Reverse Stand-Off Voltage 85V, Bidirectional Polarity Type |
| 00S0 | Internal Control Code | Letter or Digits (A~Z, a~z or 0~9) |
| ZV | Marking Code | Marking "ZV" |
| XX | Special/Custom Parameters Code | Letter or Digits (A~Z, a~z or 0~9) for Special Parametric; Blank: N/A |

DIMENSION- Unit: Inch/mm, Case SMA/DO-214AC Outline

Top View

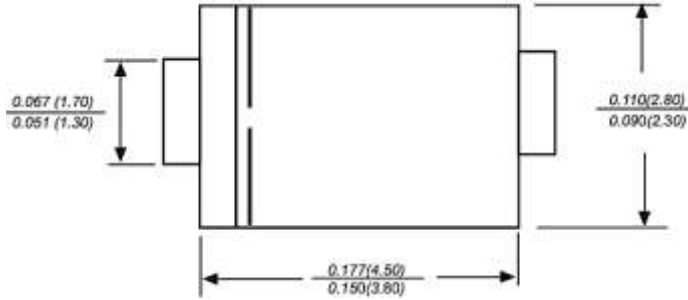

Side View

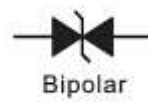
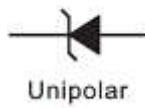
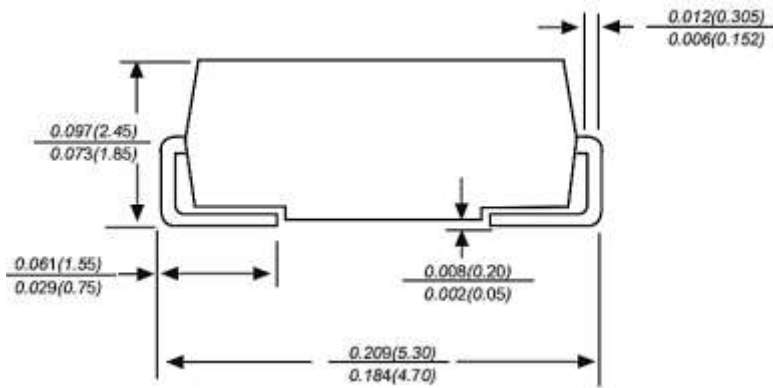

Recommend Pad Layout

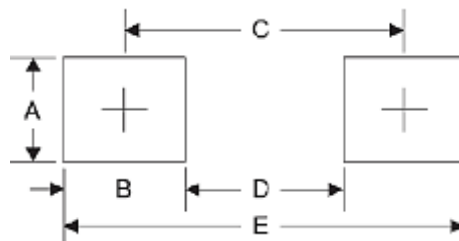

| SYMBOL | A | B | C | D | E |
|-------------|-------|-------|-------|-------|-------|
| Unit (Inch) | 0.066 | 0.060 | 0.155 | 0.095 | 0.215 |
| Unit (mm) | 1.680 | 1.520 | 3.930 | 2.41 | 5.45 |

MECHANICAL DATA

| CASE | TERMINALS | POLARITY | MOUNTING POSITION | MARKING | WEIGHT PER PIECE |
|--|---|---------------------------------------|-------------------|-----------------------------|------------------|
| JEDEC SMA/DO-214AC Molded Plastic Body | Solderable per MIL-STD- 750, Method 2026 | Polarity Symbol Marking On Body | Any | See Marking Code List | 0.070 Grams |

MAX. RATING & CHARACTERISTICS - Ratings At 25°C Ambient Temperature Unless Otherwise Specified.

| PARAMETER | SYMBOLS | VALUE | UNITS |
|---|----------|-----------------------|-------|
| Peak Pulse Power Dissipation At 10/1000µs Waveform (Note 1, Note 2, Fig. 1) | PPPM | 400 Min. | W |
| Peak Pulse Current On 10/1000 Us Waveform (Note 1, Fig. 3) | IPPM | See Page 6~page 11 | A |
| Steady State Power Dissipation At TA=50°C (Fig. 5) | PM(AV) | 3.3 | W |
| Peak Forward Surge Current, 8.3ms Single Half Sine-wave Superimposed On Rated Load (JEDEC Method) (Note 3, Fig. 6) | IFSM | 40 | A |
| Operating Junction And Storage Temperature Range. | TJ, Tstg | -65 ~ +150 | °C |
| Typical Thermal Resistance Junction To Lead | RθJL | 30 | °C/W |
| Typical Thermal Resistance Junction To Ambient | RθJA | 120 | °C/W |

Note

1. Non-repetitive current pulse, per Fig 3 and derated above TA=25 °C per Fig 2
2. Mounted on 5.0*5.0mm (0.03mm Thickness) copper pads to each terminal
3. 8.3ms single half sinewave or equivalent square wave, duty cycle=4 pulsed per minute Max.

UNIDIRECTIONAL TYPE- ELECTRICAL CHARACTERISTICS - Ta = 25°C

| Part Code | Reverse Stand-off Voltage | Breakdown Voltage | | Test Current | Reverse Leakage Max. | Max. Clamp Voltage | Peak Pulse Current | Marking Code |
|----------------|---------------------------|-------------------|------|--------------|----------------------|--------------------|--------------------|--------------|
| | | VBR @ IT | | | | | | |
| | VRWM | Min | Max | IT | IR @ VRWM | Vc @ IPP | IPP | |
| | V | V | V | mA | µA | V | A | |
| SMAJ050A00S0AE | 5 | 6.4 | 7 | 10 | 800 | 9.2 | 43.5 | AE |
| SMAJ060A00S0AG | 6 | 6.67 | 7.37 | 10 | 800 | 10.3 | 38.8 | AG |
| SMAJ065A00S0AK | 6.5 | 7.22 | 7.98 | 10 | 500 | 11.2 | 35.7 | AK |
| SMAJ070A00S0AM | 7 | 7.78 | 8.6 | 10 | 200 | 12 | 33.3 | AM |
| SMAJ075A00S0AP | 7.5 | 8.33 | 9.2 | 1 | 100 | 12.9 | 31 | AP |
| SMAJ080A00S0AR | 8 | 8.89 | 9.83 | 1 | 50 | 13.6 | 29.4 | AR |
| SMAJ085A00S0AT | 8.5 | 9.44 | 10.4 | 1 | 20 | 14.4 | 27.8 | AT |
| SMAJ090A00S0AV | 9 | 10 | 11.1 | 1 | 10 | 15.4 | 26 | AV |
| SMAJ10A000S0AX | 10 | 11.1 | 12.3 | 1 | 5 | 17 | 23.5 | AX |
| SMAJ11A000S0AZ | 11 | 12.2 | 13.5 | 1 | 1 | 18.2 | 22 | AZ |
| SMAJ12A000S0BE | 12 | 13.3 | 14.7 | 1 | 1 | 19.9 | 20.1 | BE |
| SMAJ13A000S0BG | 13 | 14.4 | 15.9 | 1 | 1 | 21.5 | 18.6 | BG |
| SMAJ14A000S0BK | 14 | 15.6 | 17.2 | 1 | 1 | 23.2 | 17.2 | BK |
| SMAJ15A000S0BM | 15 | 16.7 | 18.5 | 1 | 1 | 24.4 | 16.4 | BM |
| SMAJ16A000S0BP | 16 | 17.8 | 19.7 | 1 | 1 | 26 | 15.4 | BP |
| SMAJ17A000S0BR | 17 | 18.9 | 20.9 | 1 | 1 | 27.6 | 14.5 | BR |
| SMAJ18A000S0BT | 18 | 20 | 22.1 | 1 | 1 | 29.2 | 13.7 | BT |
| SMAJ20A000S0BV | 20 | 22.2 | 24.5 | 1 | 1 | 32.4 | 12.3 | BV |
| SMAJ22A000S0BX | 22 | 24.4 | 26.9 | 1 | 1 | 35.5 | 11.3 | BX |
| SMAJ24A000S0BZ | 24 | 26.7 | 29.5 | 1 | 1 | 38.9 | 10.3 | BZ |

UNIDIRECTIONAL TYPE- ELECTRICAL CHARACTERISTICS - Ta = 25°C

| Part Code | Reverse Stand-off Voltage | Breakdown Voltage | | Test Current | Reverse Leakage Max. | Max. Clamp Voltage | Peak Pulse Current | Marking Code |
|----------------|---------------------------|-------------------|------|--------------|----------------------|--------------------|--------------------|--------------|
| | | VBR @ IT | | | | | | |
| | VRWM | Min | Max | IT | IR @ VRWM | Vc @ IPP | IPP | |
| V | V | V | mA | µA | V | A | | |
| SMAJ26A000S0CE | 26 | 28.9 | 31.9 | 1 | 1 | 42.1 | 9.5 | CE |
| SMAJ28A000S0CG | 28 | 31.1 | 34.4 | 1 | 1 | 45.4 | 8.8 | CG |
| SMAJ30A000S0CK | 30 | 33.3 | 36.8 | 1 | 1 | 48.4 | 8.3 | CK |
| SMAJ33A000S0CM | 33 | 36.7 | 40.6 | 1 | 1 | 53.3 | 7.5 | CM |
| SMAJ36A000S0CP | 36 | 40 | 44.2 | 1 | 1 | 58.1 | 6.9 | CP |
| SMAJ40A000S0CR | 40 | 44.4 | 49.1 | 1 | 1 | 64.5 | 6.2 | CR |
| SMAJ43A000S0CT | 43 | 47.8 | 52.8 | 1 | 1 | 69.4 | 5.8 | CT |
| SMAJ45A000S0CV | 45 | 50 | 55.3 | 1 | 1 | 72.7 | 5.5 | CV |
| SMAJ48A000S0CX | 48 | 53.3 | 58.9 | 1 | 1 | 77.4 | 5.2 | CX |
| SMAJ51A000S0CZ | 51 | 56.7 | 62.7 | 1 | 1 | 82.4 | 4.9 | CZ |
| SMAJ54A000S0RE | 54 | 60 | 66.3 | 1 | 1 | 87.1 | 4.6 | RE |
| SMAJ58A000S0RG | 58 | 64.4 | 71.2 | 1 | 1 | 93.6 | 4.3 | RG |
| SMAJ60A000S0RK | 60 | 66.7 | 73.7 | 1 | 1 | 96.8 | 4.1 | RK |
| SMAJ64A000S0RM | 64 | 71.1 | 78.6 | 1 | 1 | 103 | 3.9 | RM |
| SMAJ70A000S0RP | 70 | 77.8 | 86 | 1 | 1 | 113 | 3.5 | RP |
| SMAJ75A000S0RR | 75 | 83.3 | 92.1 | 1 | 1 | 121 | 3.3 | RR |
| SMAJ78A000S0RT | 78 | 86.7 | 95.8 | 1 | 1 | 126 | 3.2 | RT |
| SMAJ85A000S0RV | 85 | 94.4 | 104 | 1 | 1 | 137 | 2.9 | RV |
| SMAJ90A000S0RX | 90 | 100 | 111 | 1 | 1 | 146 | 2.7 | RX |
| SMAJ100A00S0RZ | 100 | 111 | 123 | 1 | 1 | 162 | 2.5 | RZ |

UNIDIRECTIONAL TYPE- ELECTRICAL CHARACTERISTICS - Ta = 25°C

| Part Code | Reverse Stand-off Voltage | Breakdown Voltage | | Test Current | Reverse Leakage Max. | Max. Clamp Voltage | Peak Pulse Current | Marking Code |
|----------------|---------------------------|-------------------|-----|--------------|----------------------|--------------------|--------------------|--------------|
| | | VBR @ IT | | | | | | |
| | VRWM | Min | Max | IT | IR @ VRWM | Vc @ IPP | IPP | |
| | V | V | V | mA | µA | V | A | |
| SMAJ110A00S0SE | 110 | 122 | 135 | 1 | 1 | 177 | 2.3 | SE |
| SMAJ120A00S0SG | 120 | 133 | 147 | 1 | 1 | 193 | 2.1 | SG |
| SMAJ130A00S0SK | 130 | 144 | 159 | 1 | 1 | 209 | 1.9 | SK |
| SMAJ150A00S0SM | 150 | 167 | 185 | 1 | 1 | 243 | 1.6 | SM |
| SMAJ160A00S0SP | 160 | 178 | 197 | 1 | 1 | 259 | 1.5 | SP |
| SMAJ170A00S0SR | 170 | 189 | 209 | 1 | 1 | 275 | 1.5 | SR |
| SMAJ180A00S0ST | 180 | 201 | 222 | 1 | 1 | 292 | 1.4 | ST |
| SMAJ190A00S0SU | 190 | 211 | 232 | 1 | 1 | 308 | 1.3 | SU |
| SMAJ200A00S0SV | 200 | 224 | 247 | 1 | 1 | 324 | 1.2 | SV |
| SMAJ210A00S0SW | 210 | 237 | 263 | 1 | 1 | 340 | 1.2 | SW |
| SMAJ220A00S0GE | 220 | 246 | 272 | 1 | 1 | 356 | 1.1 | GE |
| SMAJ250A00S0SZ | 250 | 279 | 309 | 1 | 1 | 405 | 1.0 | SZ |
| SMAJ300A00S0TE | 300 | 335 | 371 | 1 | 1 | 486 | 0.8 | TE |
| SMAJ350A00S0TG | 350 | 391 | 432 | 1 | 1 | 567 | 0.7 | TG |
| SMAJ400A00S0TK | 400 | 447 | 494 | 1 | 1 | 648 | 0.6 | TK |
| SMAJ440A00S0TM | 440 | 492 | 543 | 1 | 1 | 713 | 0.6 | TM |
| | | | | | | | | |
| | | | | | | | | |
| | | | | | | | | |
| | | | | | | | | |

BIDIRECTIONAL TYPE- ELECTRICAL CHARACTERISTICS - Ta = 25°C

| Part Code | Reverse Stand-off Voltage | Breakdown Voltage | | Test Current | Reverse Leakage Max. | Max. Clamp Voltage | Peak Pulse Current | Marking Code |
|----------------|---------------------------|-------------------|------|--------------|----------------------|--------------------|--------------------|--------------|
| | | VBR @ IT | | | | | | |
| | VRWM | Min | Max | IT | IR @ VRWM | Vc @ IPP | IPP | |
| | V | V | V | mA | µA | V | A | |
| SMAJ050CA0S0WE | 5 | 6.4 | 7 | 10 | 800 | 9.2 | 43.5 | WE |
| SMAJ060CA0S0WG | 6 | 6.67 | 7.37 | 10 | 800 | 10.3 | 38.8 | WG |
| SMAJ065CA0S0WK | 6.5 | 7.22 | 7.98 | 10 | 500 | 11.2 | 35.7 | WK |
| SMAJ070CA0S0WM | 7 | 7.78 | 8.6 | 10 | 200 | 12 | 33.3 | WM |
| SMAJ075CA0S0WP | 7.5 | 8.33 | 9.2 | 1 | 100 | 12.9 | 31 | WP |
| SMAJ080CA0S0WR | 8 | 8.89 | 9.83 | 1 | 50 | 13.6 | 29.4 | WR |
| SMAJ085CA0S0WT | 8.5 | 9.44 | 10.4 | 1 | 20 | 14.4 | 27.8 | WT |
| SMAJ090CA0S0WV | 9 | 10 | 11.1 | 1 | 10 | 15.4 | 26 | WV |
| SMAJ10CA00S0WX | 10 | 11.1 | 12.3 | 1 | 5 | 17 | 23.5 | WX |
| SMAJ11CA00S0WZ | 11 | 12.2 | 13.5 | 1 | 1 | 18.2 | 22 | WZ |
| SMAJ12CA00S0XE | 12 | 13.3 | 14.7 | 1 | 1 | 19.9 | 20.1 | XE |
| SMAJ13CA00S0XG | 13 | 14.4 | 15.9 | 1 | 1 | 21.5 | 18.6 | XG |
| SMAJ14CA00S0XK | 14 | 15.6 | 17.2 | 1 | 1 | 23.2 | 17.2 | XK |
| SMAJ15CA00S0XM | 15 | 16.7 | 18.5 | 1 | 1 | 24.4 | 16.4 | XM |
| SMAJ16CA00S0XP | 16 | 17.8 | 19.7 | 1 | 1 | 26 | 15.4 | XP |
| SMAJ17CA00S0XR | 17 | 18.9 | 20.9 | 1 | 1 | 27.6 | 14.5 | XR |
| SMAJ18CA00S0XT | 18 | 20 | 22.1 | 1 | 1 | 29.2 | 13.7 | XT |
| SMAJ20CA00S0XV | 20 | 22.2 | 24.5 | 1 | 1 | 32.4 | 12.3 | XV |
| SMAJ22CA00S0XX | 22 | 24.4 | 26.9 | 1 | 1 | 35.5 | 11.3 | XX |
| SMAJ24CA00S0XZ | 24 | 26.7 | 29.5 | 1 | 1 | 38.9 | 10.3 | XZ |

BIDIRECTIONAL TYPE- ELECTRICAL CHARACTERISTICS - Ta = 25°C

| Part Code | Reverse Stand-off Voltage | Breakdown Voltage | | Test Current | Reverse Leakage Max. | Max. Clamp Voltage | Peak Pulse Current | Marking Code |
|--------------------------------|---------------------------|-------------------|------|--------------|----------------------|--------------------|--------------------|--------------|
| | | VBR @ IT | | | | | | |
| | VRWM | Min | Max | IT | IR @ VRWM | Vc @ IPP | IPP | |
| V | V | V | mA | µA | V | A | | |
| SMAJ26CA00S0YE | 26 | 28.9 | 31.9 | 1 | 1 | 42.1 | 9.5 | YE |
| SMAJ28CA00S0YG | 28 | 31.1 | 34.4 | 1 | 1 | 45.4 | 8.8 | YG |
| SMAJ30CA00S0YK | 30 | 33.3 | 36.8 | 1 | 1 | 48.4 | 8.3 | YK |
| SMAJ33CA00S0YM | 33 | 36.7 | 40.6 | 1 | 1 | 53.3 | 7.5 | YM |
| SMAJ36CA00S0YP | 36 | 40 | 44.2 | 1 | 1 | 58.1 | 6.9 | YP |
| SMAJ40CA00S0YR | 40 | 44.4 | 49.1 | 1 | 1 | 64.5 | 6.2 | YR |
| SMAJ43CA00S0YT | 43 | 47.8 | 52.8 | 1 | 1 | 69.4 | 5.8 | YT |
| SMAJ45CA00S0YV | 45 | 50 | 55.3 | 1 | 1 | 72.7 | 5.5 | YV |
| SMAJ48CA00S0YX | 48 | 53.3 | 58.9 | 1 | 1 | 77.4 | 5.2 | YX |
| SMAJ51CA00S0YZ | 51 | 56.7 | 62.7 | 1 | 1 | 82.4 | 4.9 | YZ |
| SMAJ54CA00S0ZE | 54 | 60 | 66.3 | 1 | 1 | 87.1 | 4.6 | ZE |
| SMAJ58CA00S0ZG | 58 | 64.4 | 71.2 | 1 | 1 | 93.6 | 4.3 | ZG |
| SMAJ60CA00S0ZK | 60 | 66.7 | 73.7 | 1 | 1 | 96.8 | 4.1 | ZK |
| SMAJ64CA00S0ZM | 64 | 71.1 | 78.6 | 1 | 1 | 103 | 3.9 | ZM |
| SMAJ70CA00S0ZP | 70 | 77.8 | 86 | 1 | 1 | 113 | 3.5 | ZP |
| SMAJ75CA00S0ZR | 75 | 83.3 | 92.1 | 1 | 1 | 121 | 3.3 | ZR |
| SMAJ78CA00S0ZT | 78 | 86.7 | 95.8 | 1 | 1 | 126 | 3.2 | ZT |
| SMAJ85CA00S0ZV | 85 | 94.4 | 104 | 1 | 1 | 137 | 2.9 | ZV |
| SMAJ90CA00S0ZX | 90 | 100 | 111 | 1 | 1 | 146 | 2.7 | ZX |
| SMAJ100CA00S0ZZ | 100 | 111 | 123 | 1 | 1 | 162 | 2.5 | ZZ |

BIDIRECTIONAL TYPE- ELECTRICAL CHARACTERISTICS - Ta = 25°C

| Part Code | Reverse Stand-off Voltage | Breakdown Voltage | | Test Current | Reverse Leakage Max. | Max. Clamp Voltage | Peak Pulse Current | Marking Code |
|----------------|---------------------------|-------------------|-----|--------------|----------------------|--------------------|--------------------|--------------|
| | | VBR @ IT | | | | | | |
| | VRWM | Min | Max | IT | IR @ VRWM | Vc @ IPP | IPP | |
| | V | V | V | mA | µA | V | A | |
| SMAJ110CA0S0VE | 110 | 122 | 135 | 1 | 1 | 177 | 2.3 | VE |
| SMAJ120CA0S0VG | 120 | 133 | 147 | 1 | 1 | 193 | 2.1 | VG |
| SMAJ130CA0S0VK | 130 | 144 | 159 | 1 | 1 | 209 | 1.9 | VK |
| SMAJ150CA0S0VM | 150 | 167 | 185 | 1 | 1 | 243 | 1.6 | VM |
| SMAJ160CA0S0VP | 160 | 178 | 197 | 1 | 1 | 259 | 1.5 | VP |
| SMAJ170CA0S0VR | 170 | 189 | 209 | 1 | 1 | 275 | 1.5 | VR |
| SMAJ180CA0S0VT | 180 | 201 | 222 | 1 | 1 | 292 | 1.4 | VT |
| SMAJ190CA0S0YU | 190 | 211 | 232 | 1 | 1 | 308 | 1.3 | YU |
| SMAJ200CA0S0VV | 200 | 224 | 247 | 1 | 1 | 324 | 1.2 | VV |
| SMAJ210CA0S0YW | 210 | 237 | 263 | 1 | 1 | 340 | 1.2 | YW |
| SMAJ220CA0S0VX | 220 | 246 | 272 | 1 | 1 | 356 | 1.1 | VX |
| SMAJ250CA0S0VZ | 250 | 279 | 309 | 1 | 1 | 405 | 1.0 | VZ |
| SMAJ300CA0S0UE | 300 | 335 | 371 | 1 | 1 | 486 | 0.8 | UE |
| SMAJ350CA0S0UG | 350 | 391 | 432 | 1 | 1 | 567 | 0.7 | UG |
| SMAJ400CA0S0UK | 400 | 447 | 494 | 1 | 1 | 648 | 0.6 | UK |
| SMAJ440CA0S0UM | 440 | 492 | 543 | 1 | 1 | 713 | 0.6 | UM |
| | | | | | | | | |
| | | | | | | | | |

Note: For Bidirectional Type Having Vrwm Of 10V And Less, The Ir Limit Is Double.

RATINGS AND CHARACTERISTICS CURVES- FOR REFERENCE ONLY, $T_A=25^\circ\text{C}$ UNLESS OTHERWISE SPECIFIED.

Figure 1. Peak Pulse Power Rating Curve

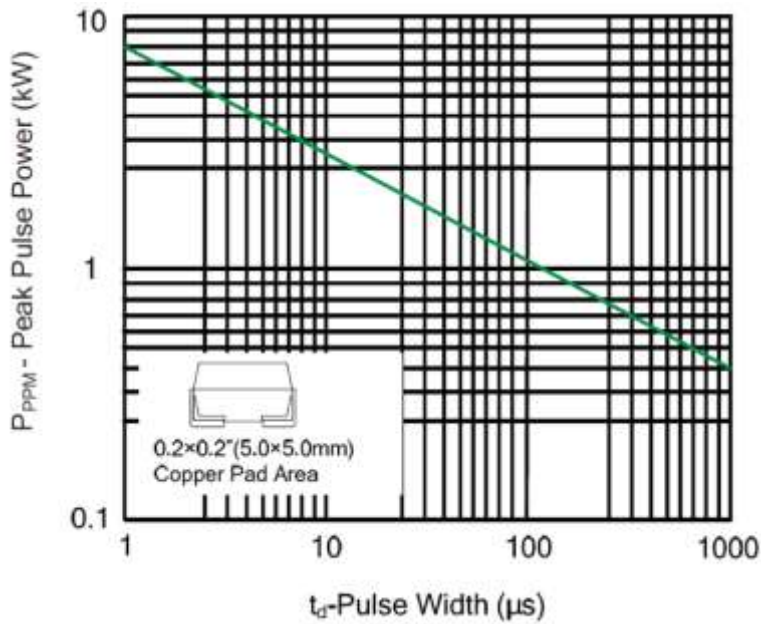
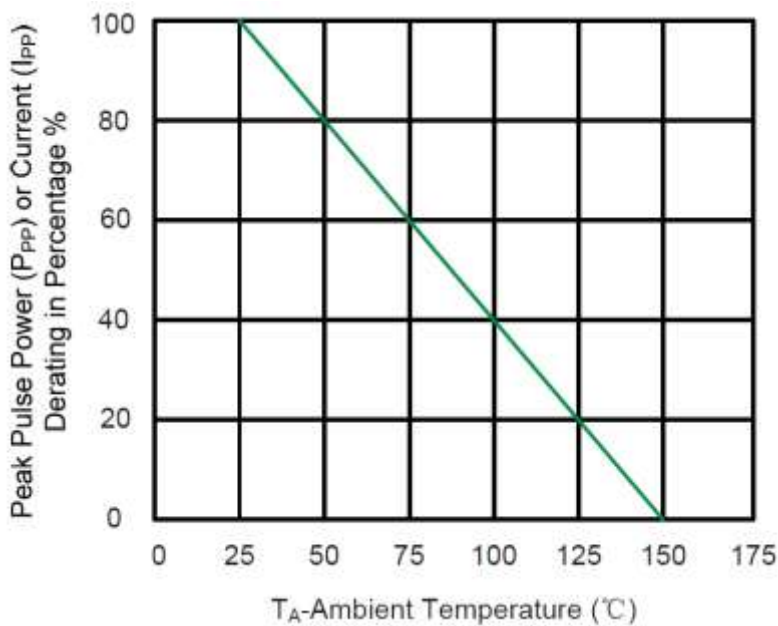

Figure 2. Pulse Derating Curve



RATINGS AND CHARACTERISTICS CURVES- FOR REFERENCE ONLY, $T_A=25^\circ\text{C}$ UNLESS OTHERWISE SPECIFIED.

Figure 3. Pulse Waveform

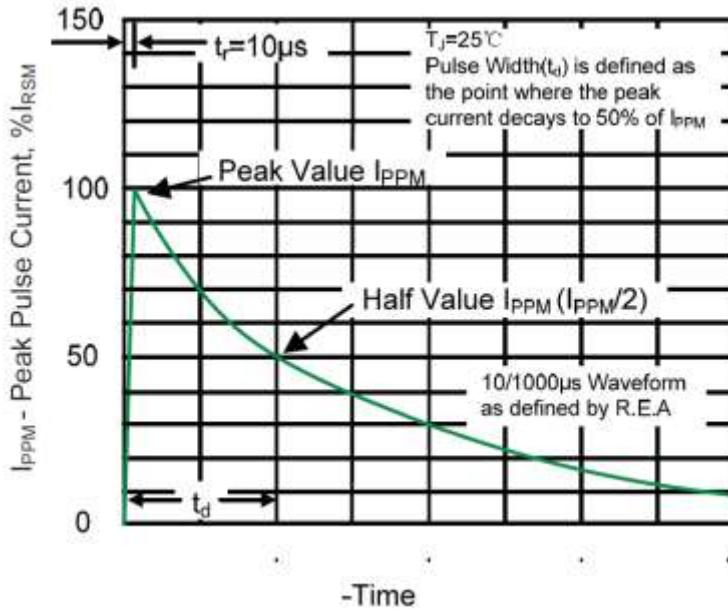
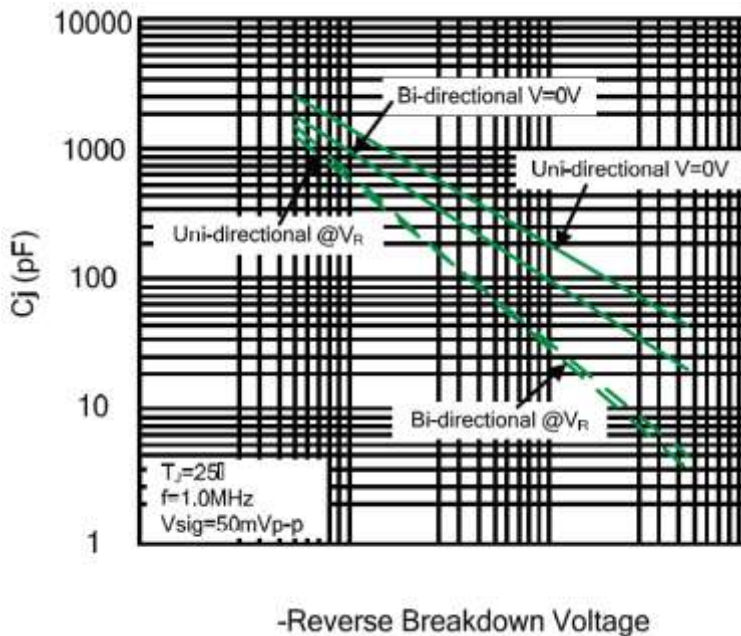

Figure 4. Typical Junction Capacitance



RATINGS AND CHARACTERISTICS CURVES- FOR REFERENCE ONLY, $T_A=25^\circ\text{C}$ UNLESS OTHERWISE SPECIFIED.

Figure 5. Steady State Power Dissipation Derating curve

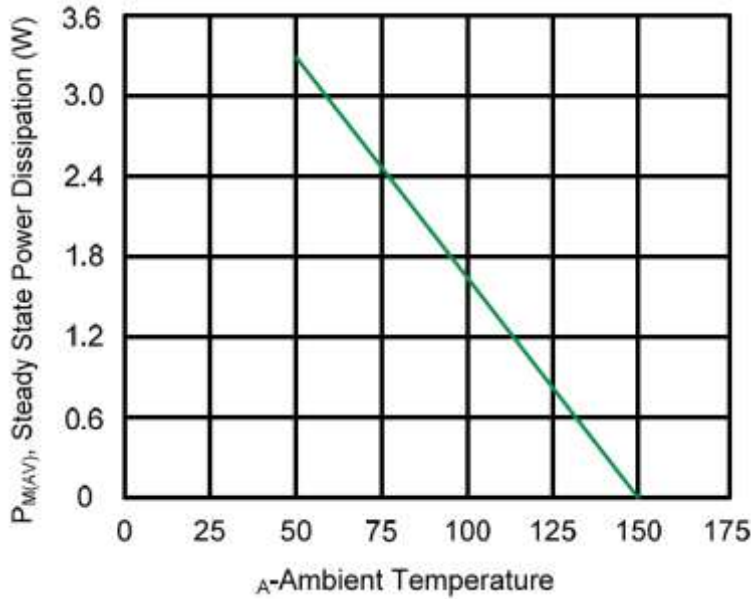
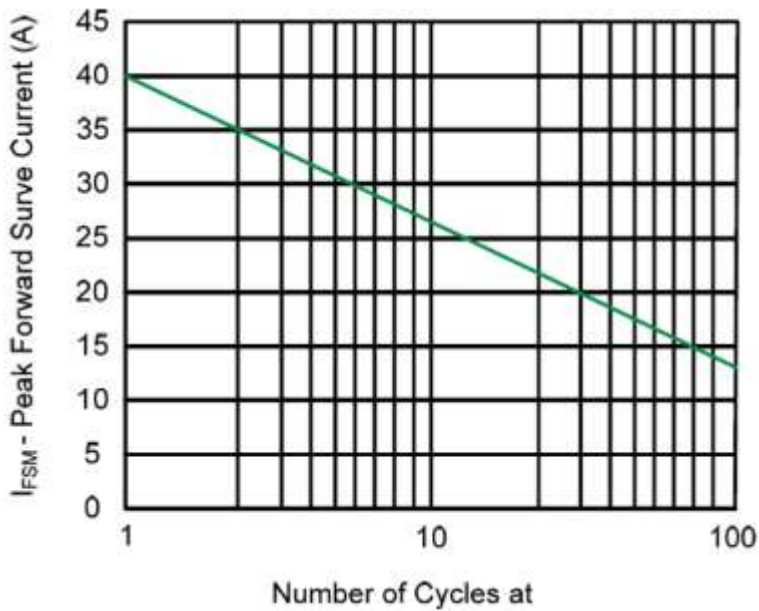
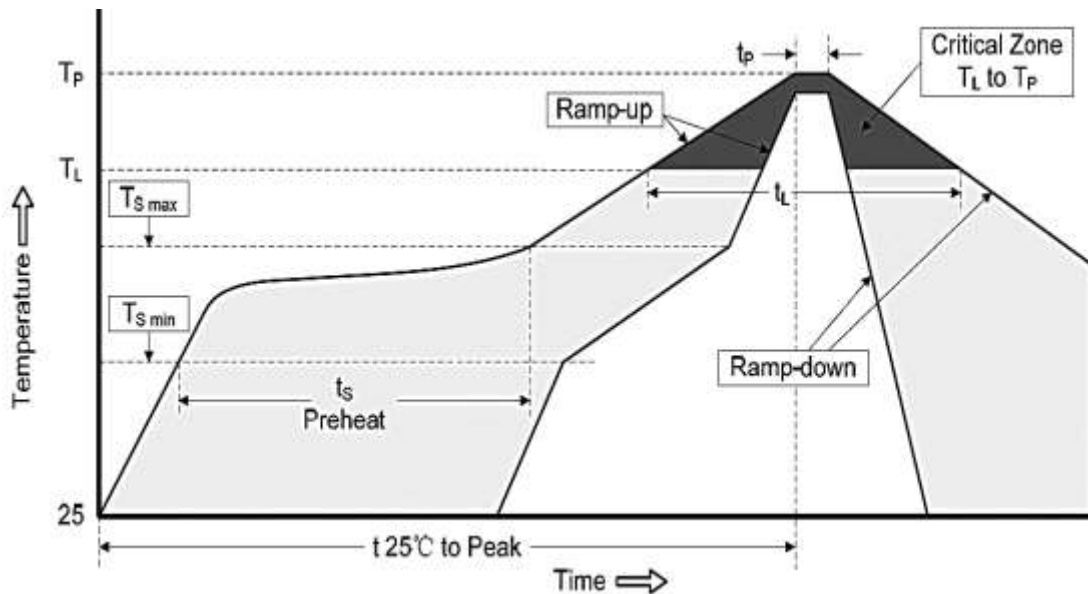

Figure 6. Maximum Non-Repetitive Forward Surge Current Uni-Directional Only



RECOMMENDED SOLDERING PARAMETERS – FOR REFERENCE ONLY



| PROFILE FEATURE | | PB-FREE ASSEMBLY |
|--|----------------------------------|-------------------|
| Average Ramp-up Rate (T_L to T_P) | | 3°C/second Max |
| Preheat | Temperature Min (T_s Min.) | 150°C |
| | Temperature Max (T_s Max.) | 200°C |
| | Time (t_s Min. to t_s Max.) | 60 ~ 180 seconds |
| $T_{s\ max}$ to T_L Ramp-up Rate | | 3°C/second Max |
| Time maintained above | Temperature (T_L) | 217°C |
| | Time (t_L) | 60 ~ 150 seconds |
| Peak/Classification Temperature (T_P) | | 260 °C |
| Time within 5°C of actual Peak Temperature (t_p) | | 20 ~ 40 seconds |
| Ramp-down Rate | | 6 °C /Second Max. |
| Time 25 °C to Peak Temperature | | 8 Minutes Max. |
| Suggest reflow times | | 3 Times Max. |

TAPE/REEL - Unit: mm, All Devices are packed in accordance with EIA standard RS-481-A and specifications

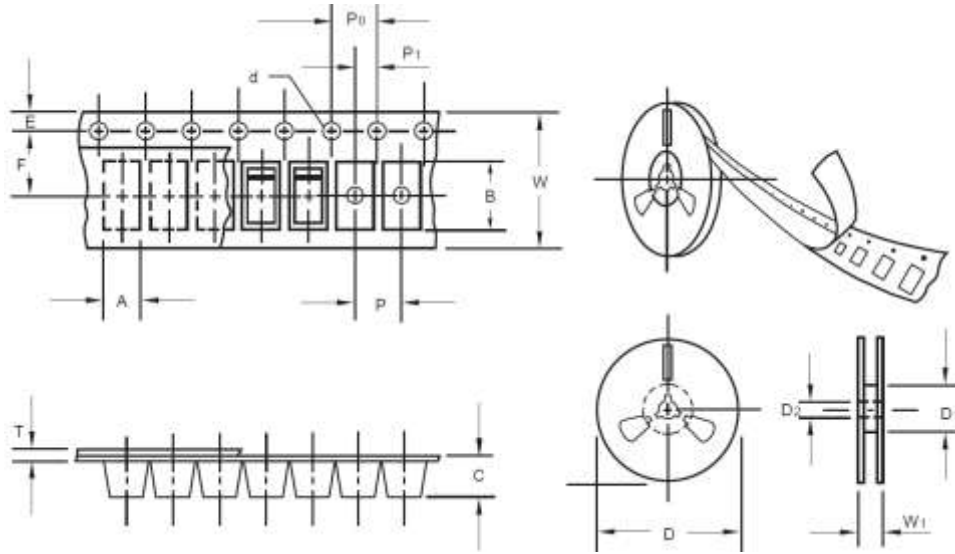

| ITEM | SYMBOL | TOLERANCE | SMA/DO-214AC |
|---------------------------|--------|-----------|--------------|
| Carrier width | A | 0.1 | 2.80 |
| Carrier Length | B | 0.1 | 5.33 |
| Carrier Depth | C | 0.1 | 2.36 |
| Sprocket hole | d | 0.05 | 1.50 |
| 13" Reel outside diameter | D | 2.0 | 330.0 |
| 13" Reel inner diameter | D1 | Min. | 50.0Min. |
| Feed hole diameter | D2 | 0.5 | 13.00 |
| Sprocket hole position | E | 0.1 | 1.75 |
| Punch hole position | F | 0.1 | 5.50 |
| Punch hole pitch | P | 0.1 | 4.00 |
| Sprocket hole pitch | P0 | 0.1 | 4.00 |
| Embossment center | P1 | 0.1 | 2.0 |
| Overall tape thickness | T | 0.1 | 0.28 |
| Tape width | W | 0.3 | 12.00 |
| Reel width | W1 | 1.0 | 18.0 |
| Qty./Reel (pcs) | 5000 | | |

IMPORTANT NOTES AND DISCLAIMER

1. **ROHS COMPLIANCE:** The levels of RoHS restricted materials in this product are below the maximum concentration values (also referred to as the threshold limits) permitted for such substances, or are used in an exempted application, in accordance with EU RoHS Directive (EU) 2015/863 EC (RoHS3). RoHS Test Report for this product can be obtained at Download Center.
2. **REACH COMPLIANCE:** REACH substances of high concern (SVHCs) information is available for this product. Since the European Chemical Agency (ECHA) has published notice of their intent to frequently revise the SVHC listing for the foreseeable future, REACH Test Report for this product can be obtained at Download Center.
3. All Product parametric performance is indicated in the Electrical Characteristics for the listed herein test conditions, unless otherwise noted. Product performance may not be indicated by the Electrical Characteristics if operated under different conditions.
4. NextGen Component, Inc (*NextGen*) reserves the right to make changes to this document and its products and specifications at any time without notice. Customers should obtain and confirm the latest product information and specifications before final design, purchase or use.
5. *NextGen* makes no warranty, representation or guarantee regarding the suitability of its products for any particular purpose, not does *NextGen* assume any liability for application assistance or customer product design.
6. *NextGen* does not warrant or accept any liability with products which are purchased or used for any unintended or unauthorized application. No license is granted by implication or otherwise under any intellectual property rights of NextGen.
7. *NextGen* products are not authorized for use as critical components in life support devices or systems without express written approval by *NextGen*.
8. *NextGen* requires that customers first obtain an RMA (Returned Merchandise Authorization) number prior to returning any products. Returns must be made within 30 days of the date of invoice, be in the original packaging, unused and like-new condition. At the time of quoting or purchasing, a product may say that it is Non-Cancelable/ Non-Returnable (NCNR). These products are not returnable and not refundable.