





SPECIFICATION SHEET NO.	T0130 – 1N4148WS00S0T4	
ORIGINAL MFG/PART NO.	 MDD Diodes/1N4148WS/SOD323148WSST4	
NEXTGEN PART CODE	1N4148WS00S0T4	Indicate This Code For <a href="#">RFQ</a> /Order
DATE	Jan. 30, 2026	
REVISION	A5	Updated With Most Recent Data
DESCRIPTION AND MAIN PARAMETRICS	<p>SMD Fast Switching Diodes, Case SOD-323 1N4 Series, 2 Pads</p> <p>Reverse Voltage: 100V Max.</p> <p>Forward Current 0.15A Max.</p> <p>Junction Temp. Range -55°C ~+150°C</p> <p>Package in Tape/Reel, 3000pcs/Reel</p> <p>RoHS/RoHS III compliant, RoHS Annex III lead Exemption (Exempt per RoHS EU 2015/863) and Halogen Free (HF)</p>	
CUSTOMER		
CUSTOMER PART NUMBER		
CROSS REF. PART NUMBER		
MEMO		

VENDOR APPROVE		
Issued/Checked/Approved		
		
Effective Date: Jan. 30, 2026		

CUSTOMER APPROVE	
Date:	

## MAIN FEATURE

- Fast Switching Speed
- Case Type SOD-323
- Surface Mount Package Ideally Suited For Automatic Insertion
- High Conductance
- Meet MSL 1 Requirement
- Cross Competitors Parts and More.
- RoHS/RoHS III compliant, RoHS Annex III lead Exemption (Exempt per RoHS EU 2015/863) and Halogen Free (HF)



*Image shown is a representation only. Exact specifications should be obtained from the product dimension.*

## APPLICATION

- For General Purpose Switching Applications

## ELECTRICAL CHARACTERISTICS

- See Page 5 ~ Page 6.
- All Products Parameters are Subject To NextGen Components' Final Confirmation.



HOW TO ORDER

- Please Follow Up Part Code Guide And Indicate NextGen Part Code 1N4148WS00S0T4 For RFQ and Order.

PART CODE GUIDE

**RFQ**  
Request For Quotation

CODE	NAME	KEY SPECIFICATION OPTION
1N4	Product Series Code	SMD Fast Switching Diodes, 2 Pads
148WS	Parameters Code	Letter or Digits (A~Z, a~z or 0~9)
00S0	Internal Control Code	Letter or Digits (A~Z, a~z or 0~9)
T4	Marking Code	Marking "T4"
XX	Special/Custom Parameters Code	Letter or Digits (A~Z, a~z or 0~9) for Special Parametric; Blank: N/A

DIMENSION - Unit: mm, Case SOD-323, Inch/mm

Top View

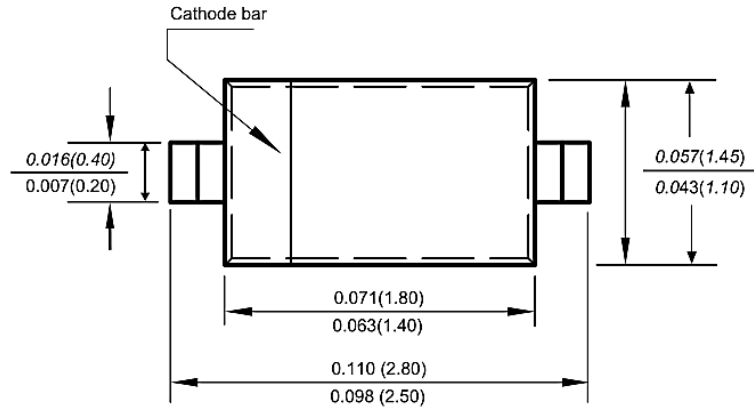

Side View

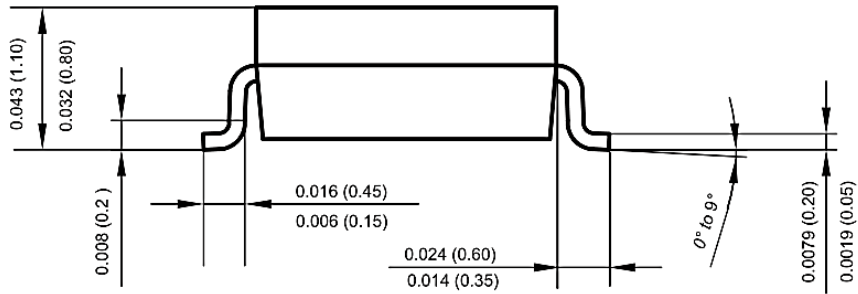

Side View

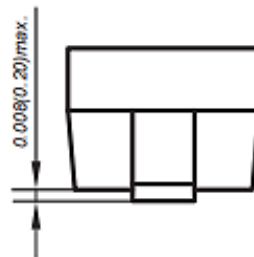

Recommend Pad Layout - Tolerance:  $\pm 0.05\text{mm}$

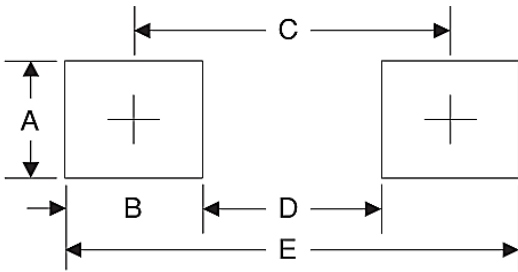

Symbol	Unit (inch)	Unit (mm)
A	0.028	0.7
B	0.028	0.7
C	0.085	2.15
D	0.057	1.45
E	0.112	2.85

### MECHANICAL CHARACTERISTICS

CASE	FLAMMABILITY RATING	TERMINALS	MARKING
JEDEC SOD-323 molded plastic body	UL 94V-0	Solder plated, solderable per MIL-STD-750, Method 2026	T4

ABSOLUTE MAX. RATING -  $T_A=25^\circ\text{C}$  unless otherwise specified, For Reference Only

PARAMETER	SYMBOLS	VALUE	UNITS
Maximum Repetitive Peak Reverse Voltage	VRRM	100	V
Maximum RMS Voltage	VRMS	75	V
Reverse Breakdown Voltage at $I_R=1\mu\text{A}$	V(BR)R	75	V
Forward Continuous Current	IFM	300	mA
Average Rectified Output Current	IO	150	mA
Peak Forward Current	IFSM	at 1s	0.5
		at 1ms	1
		at 1us	4
Power Dissipation	Pd	400	mW
Thermal Resistance Junction To Ambient	RθJA	250	$^\circ\text{C}/\text{W}$
Junction and Storage Temperature Range	TJ, TSTG	-55 ~+ 150	$^\circ\text{C}$

CHARACTERISTICS-  $T_A=25^{\circ}\text{C}$  unless otherwise specified, For Reference Only

PARAMETER	SYMBOLS	VALUE			UNITS	CONDITIONS
		Min.	Typ.	Max.		
Forward Voltage	V <sub>F1</sub>			0.715	V	I <sub>F</sub> = 1.0mA
	V <sub>F2</sub>			0.855	V	I <sub>F</sub> = 10 mA
	V <sub>F3</sub>			1.0	V	I <sub>F</sub> = 50 mA
	V <sub>F4</sub>			1.25	V	I <sub>F</sub> = 150mA
Reverse Current	I <sub>R1</sub>			0.025	μA	at V <sub>R</sub> = 20 V, T <sub>j</sub> = 25°C
	I <sub>R2</sub>			1.0	μA	at V <sub>R</sub> = 75 V, T <sub>j</sub> = 25°C
	I <sub>R3</sub>			30	μA	at V <sub>R</sub> = 25 V, T <sub>j</sub> = 150°C
	I <sub>R4</sub>			50	μA	at V <sub>R</sub> = 75V, T <sub>j</sub> = 150°C
Capacitance Between Terminals	C <sub>T</sub>			2	pF	V <sub>R</sub> =0V, f=1.0MHz
Reverse Recovery Time	t <sub>rr</sub>			4	ns	I <sub>F</sub> =I <sub>R</sub> =10mA I <sub>rr</sub> =0.1X I <sub>R</sub> , R <sub>L</sub> =100Ω

RATINGS AND CHARACTERISTICS CURVES- For Reference Only, Ta=25°C Unless Otherwise Specified.

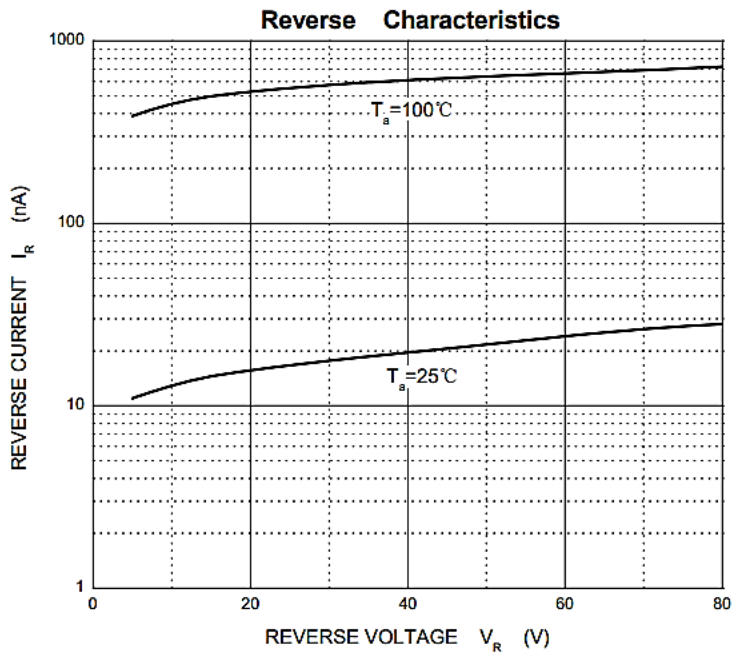
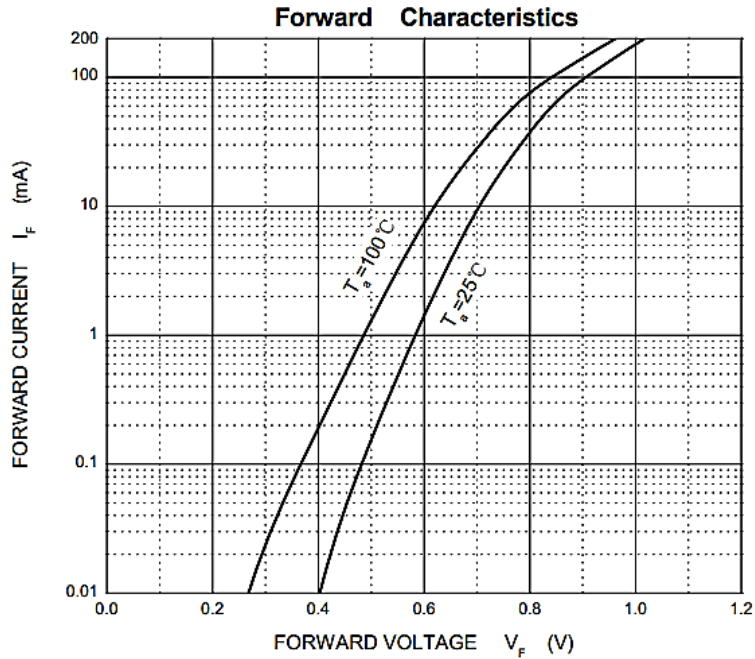

RATINGS AND CHARACTERISTICS CURVES- For Reference Only,  $T_a=25^\circ\text{C}$  Unless Otherwise Specified.

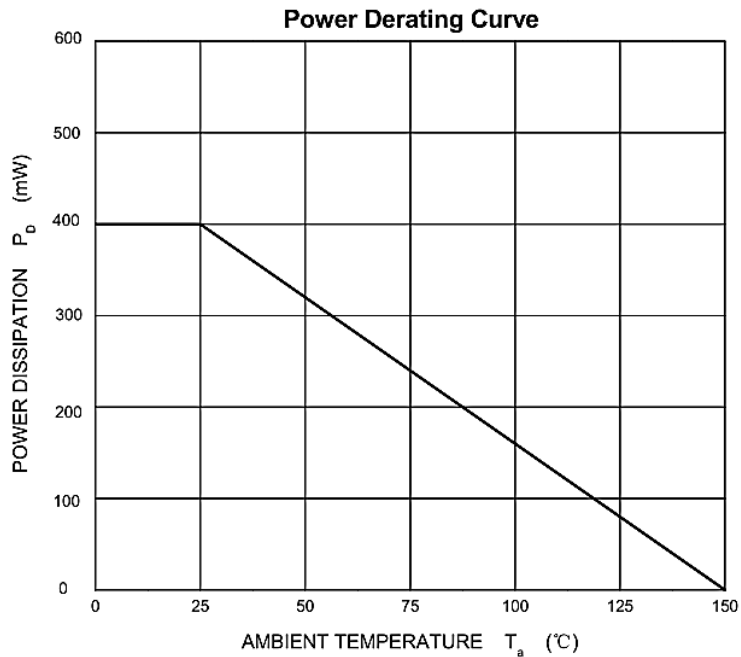
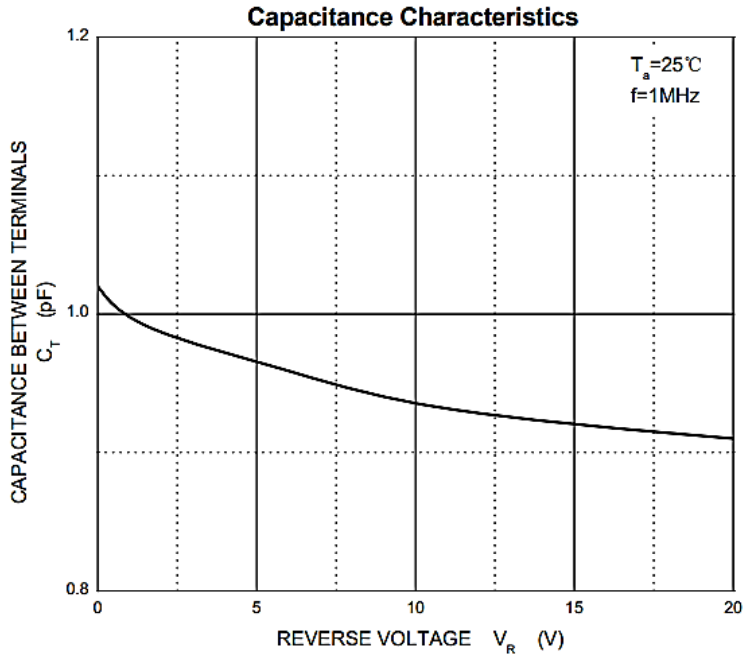

SUGGESTED REFLOW PROFILE - For Reference Only

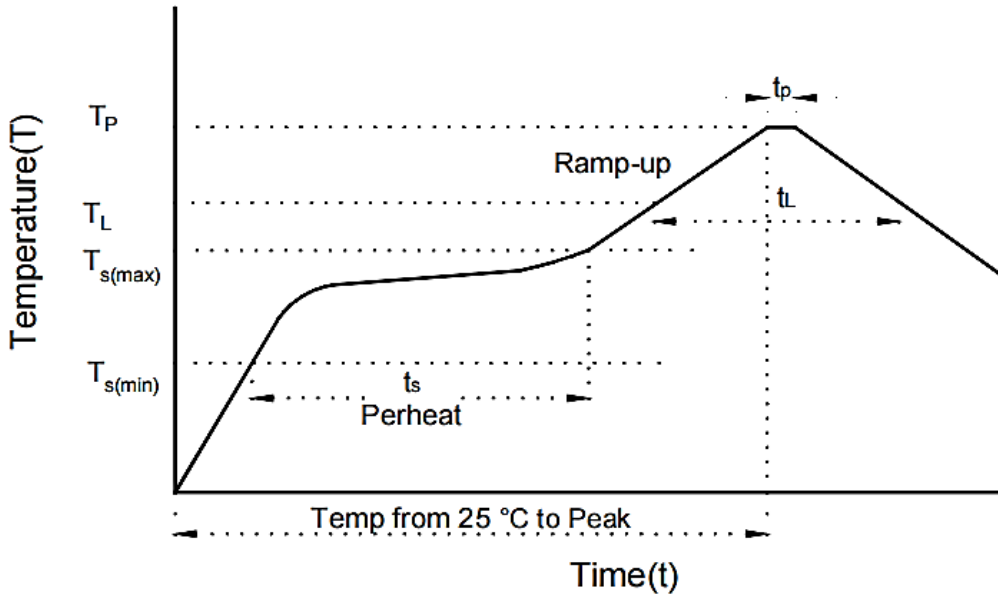

PROFILE FEATURE		PB-FREE ASSEMBLY
Average Ramp-up Rate ( $T_L$ Max to $T_p$ )		3°C/second Max
Preheat	Temperature Min ( $T_s$ Min.)	150°C
	Temperature Max ( $T_s$ Max.)	200°C
	Time ( $t_s$ Min. to $t_s$ Max.)	60 ~ 180 seconds
Time maintained above	Temperature ( $T_L$ )	217°C
	Time ( $t_L$ )	60 ~ 150 seconds
Peak/Classification Temperature ( $T_p$ )		260 °C
Time within 5°C of actual Peak Temperature ( $t_p$ )		10 seconds Max.
Ramp-down Rate		6 °C /Second Max.
Time 25 °C to Peak Temperature		8 Minutes Max.
Suggest reflow times		3 Times Max.

TAPE/REEL - Unit: mm, All Devices are packed in accordance with EIA standard RS-481-A and specifications

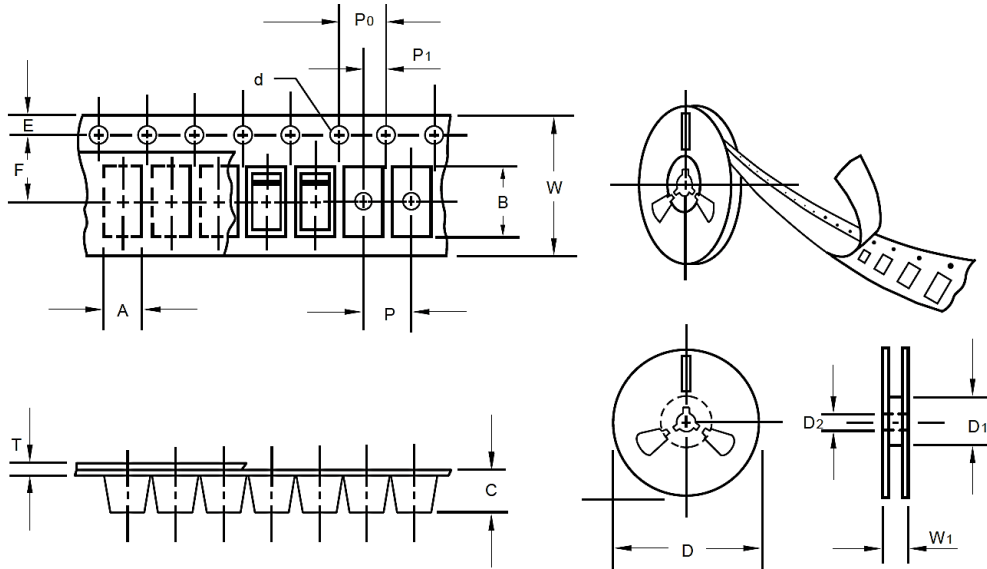

ITEM	SYMBOL	TOLERANCE	SOD-323
Carrier width	A	0.1	2.10
Carrier Length	B	0.1	4.00
Carrier Depth	C	0.1	1.60
Sprocket hole	d	0.05	1.55
7"Reel outside diameter	D	2	178
7"Reel inner diameter	D1	Min.	50
Feed hole diameter	D2	0.5	13
Sprocket hole position	E	0.1	1.75
Punch hole position	F	0.1	3.5
Punch hole pitch	P	0.1	4
Sprocket hole pitch	P0	0.1	4
Embossment center	P1	0.1	2
Overall tape thickness	T	0.1	0.25
Tape width	W	0.3	8.15
Reel width	W1	1	10.50
Qty. Per Reel (pcs)		3000	

## IMPORTANT NOTES AND DISCLAIMER

1. **ROHS COMPLIANCE:** The levels of RoHS restricted materials in this product are below the maximum concentration values (also referred to as the threshold limits) permitted for such substances, or are used in an exempted application, in accordance with EU RoHS Directive (EU) 2015/863 EC (RoHS3). RoHS Test Report for this product can be obtained at Download Center.
2. **REACH COMPLIANCE:** REACH substances of high concern (SVHCs) information is available for this product. Since the European Chemical Agency (ECHA) has published notice of their intent to frequently revise the SVHC listing for the foreseeable future, REACH Test Report for this product can be obtained at Download Center.
3. All Product parametric performance is indicated in the Electrical Characteristics for the listed herein test conditions, unless otherwise noted. Product performance may not be indicated by the Electrical Characteristics if operated under different conditions.
4. NextGen Component, Inc (*NextGen*) reserves the right to make changes to this document and its products and specifications at any time without notice. Customers should obtain and confirm the latest product information and specifications before final design, purchase or use.
5. *NextGen* makes no warranty, representation or guarantee regarding the suitability of its products for any particular purpose, not does *NextGen* assume any liability for application assistance or customer product design.
6. *NextGen* does not warrant or accept any liability with products which are purchased or used for any unintended or unauthorized application. No license is granted by implication or otherwise under any intellectual property rights of NextGen.
7. *NextGen* products are not authorized for use as critical components in life support devices or systems without express written approval by *NextGen*.
8. *NextGen* requires that customers first obtain an RMA (Returned Merchandise Authorization) number prior to returning any products. Returns must be made within 30 days of the date of invoice, be in the original packaging, unused and like-new condition. At the time of quoting or purchasing, a product may say that it is Non-Cancelable/ Non-Returnable (NCNR). These products are not returnable and not refundable.