





SPECIFICATION SHEET NO.	T0205 – 1N4148WTL0S0T4	
ORIGINAL MFG/PART NO.	 LGE Diodes/1N4148WT-L	
NEXTGEN PART CODE	1N4148WTL0S0T4	Indicate This Code For RFQ /Order
DATE	Feb. 05, 2026	
REVISION	A6	Updated With Most Recent Data
DESCRIPTION AND MAIN PARAMETRICS	<p>SMD Fast Switching Diodes, Case SOD-523 1N4 Series, 2 Pads</p> <p>Reverse Voltage (VR): 80V Max.</p> <p>Average Rectified Output Current (IO): 125mA Max.</p> <p>Junction Temp. Range 150°C</p> <p>Package in Tape/Reel, 3000pcs/Reel</p> <p>RoHS/RoHS III compliant, RoHS Annex III lead Exemption (Exempt per RoHS EU 2015/863)</p> <p>REACH compliant and Halogen-free</p>	
CUSTOMER		
CUSTOMER PART NO.		
CROSS REF. PART NO.		
MEMO		

VENDOR APPROVE			
Issued/Checked/Approved			
Date: Feb. 05, 2026			

CUSTOMER APPROVE	
Date:	

FEATURES

- Fast switching diode
- Low forward voltage and high conductance
- SOD-523 surface mount package
- Surface mount design suitable for automatic placement and reflow soldering
- Moisture Sensitivity Level: MSL 1 (Unlimited floor life)
- Suitable as cross-reference and alternative parts to major competitors
- RoHS compliant and RoHS III compliant Lead exemption in accordance with RoHS Annex III, Exempt per EU Directive 2015/863
- REACH compliant and halogen-free

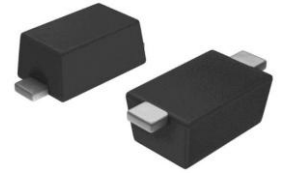

Image shown is a representation only. Exact specifications should be obtained from the product dimension.



APPLICATIONS

- General-purpose switching applications
- High-speed signal switching circuits
- Power management and polarity protection circuits (general use)
- Consumer and industrial electronic equipment

ELECTRICAL CHARACTERISTICS

- Electrical characteristics for each part number are specified under the stated test conditions and are shown on Pages 5 to 6.
- All product parameters are subject to final confirmation by NextGen Components.

HOW TO ORDER

- Please Follow Up Part Code Guide And Indicate NextGen Order Part Code 1N4148WTLOS0T4 For RFQ/Order.

PART CODE GUIDE

RFQ
[Request For Quotation](#)

CODE	NAME	KEY SPECIFICATION OPTION
1N4	Product Series Code	SMD Fast Switching Diodes, 2 Pads
148WT	Parameters Code	Letter or Digits (A~Z, a~z or 0~9)
LOS0	Internal Control Code	Letter or Digits (A~Z, a~z or 0~9)
T4	Marking Code	Marking "T4"
XX	Special/Custom Parameters Code	Letter or Digits (A~Z, a~z or 0~9) for Special Parametric; Blank: N/A

DIMENSION - (Unit: mm) Case SOD-523

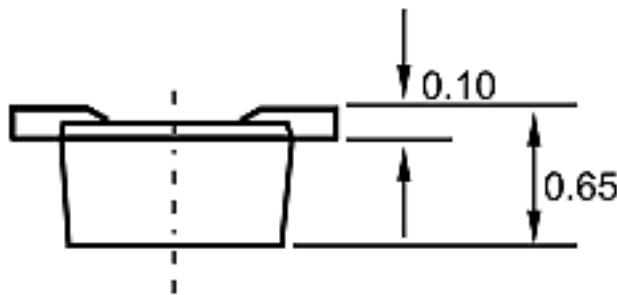
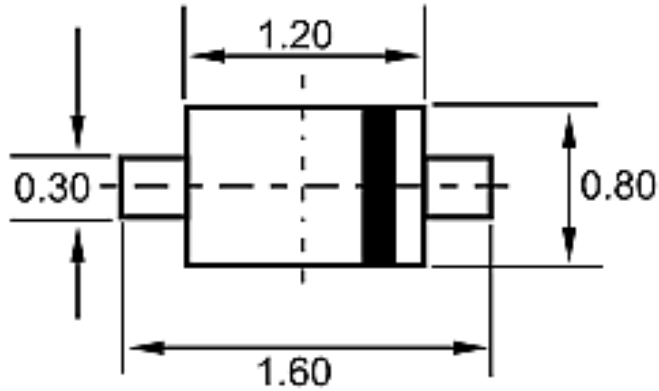

Circuit Diagram

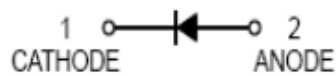
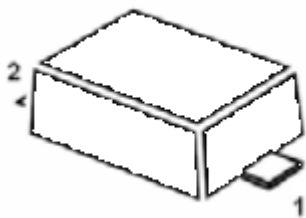

MECHANICAL CHARACTERISTICS

CASE	MOLDING COMPOUND	TERMINALS	MARKING
JEDEC SOD-523 molded plastic body	UL Flammability Classification Rating 94V-0	Matte tin-plated leads; Solderability-per MIL-STD-202, Method 208	T4

MAX. RATING - TA=25°C unless otherwise specified, For Reference Only

PARAMETER	SYMBOLS	VALUE	UNITS
Non-Repetitive Peak Reverse Voltage	VRM	100	V
Reverse Voltage	VR	80	V
RMS Reverse Voltage	VR(RMS)	80	V
Max Continuous Forward Current	IFM	250	mA
Average Rectified Output Current	IO	125	mA
Non-Repetitive Peak Forward Surge Current	@t=1.0μs	2	A
	@t=100ms	1	A
Total Power Dissipation	Ptot	150	mW
Thermal Resistance From Junction To Ambient Air	RθJA	833	°C/W
Junction temperature	TJ	150	°C
Storage Temperature Range	Tstg	-65 ~+ 150	°C

ELECTRICAL CHARACTERISTICS - TA=25°C unless otherwise specified, For Reference Only

PARAMETER	SYMBOLS	TEST CONDITION	VALUE MIN.	VALUE TYP.	VALUE MAX.	UNITS
Reverse Breakdown Voltage	V(BR)R	IR=1.0μA	75	-	-	V
Forward Voltage	VF	IF=1mA	-	-	0.715	V
		IF=10mA	-	-	0.855	
		IF=50mA	-	-	1.00	
		IF=150mA	-	-	1.25	
Reverse Current	IR	VR=75V	-	-	1.0	μA
		VR=20V	-	-	25	nA
Diode Capacitance	Cd	VR = 0V, f = 1.0MHz	-	-	2	pF
Reverse Recovery Time	t _{rr}	IF = IR = 10mA I _{rr} = 0.1×IR, RL = 100Ω	-	-	4	ns

RATINGS AND CHARACTERISTICS CURVES - For Reference Only, $T_a=25^\circ\text{C}$ Unless Otherwise Specified.

Fig. 1 Derating Curve

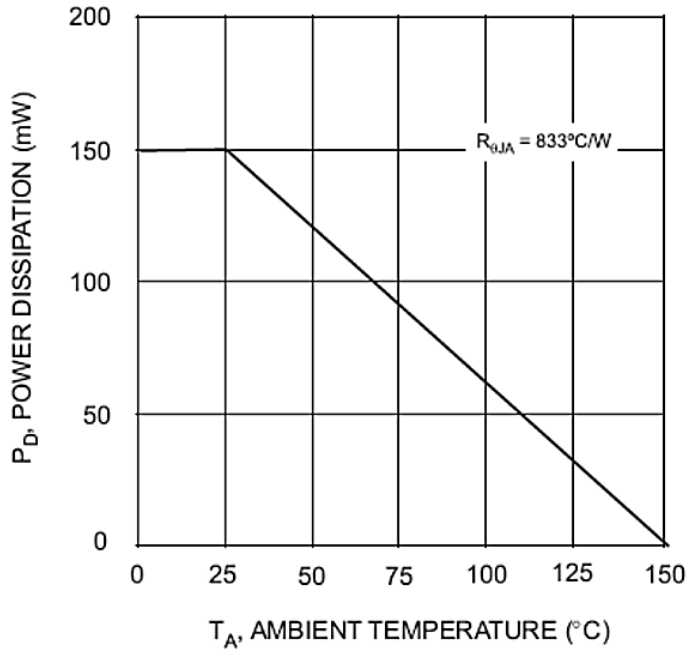
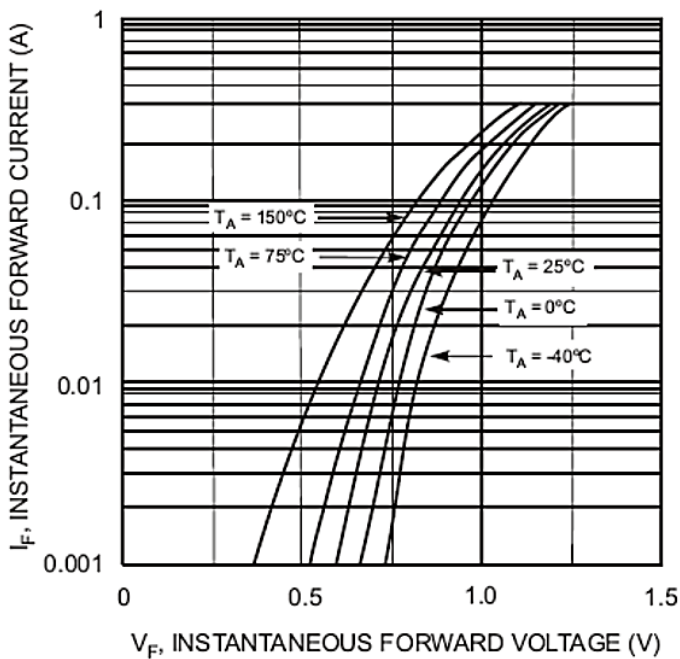

Fig. 2 Forward Characteristics



RATINGS AND CHARACTERISTICS CURVES - For Reference Only, $T_a=25^\circ\text{C}$ Unless Otherwise Specified.

Fig. 3 Typical Reverse Characteristics

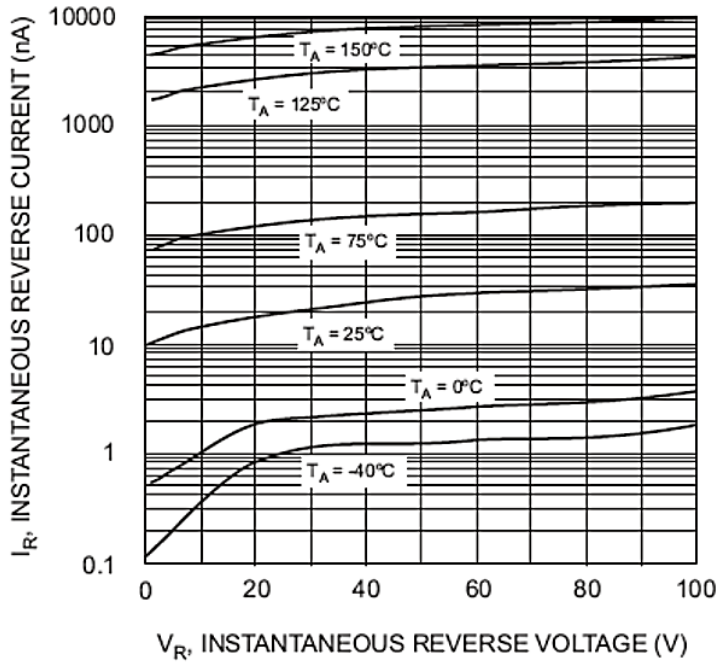
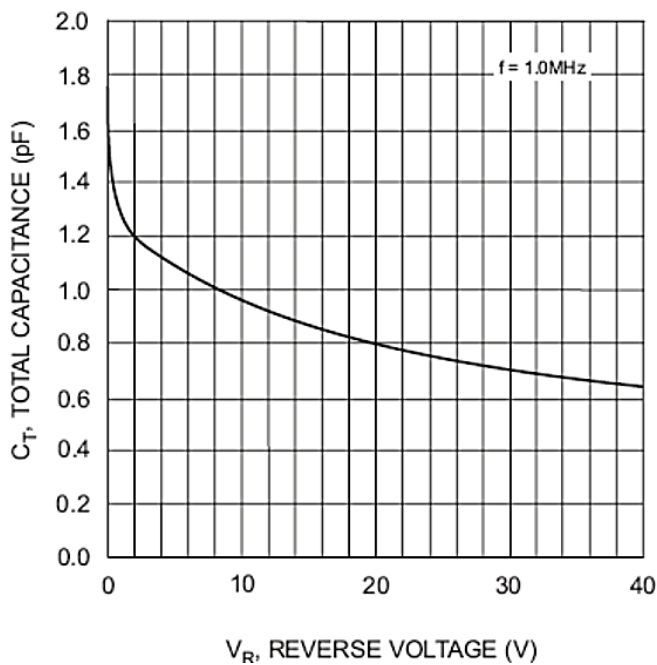
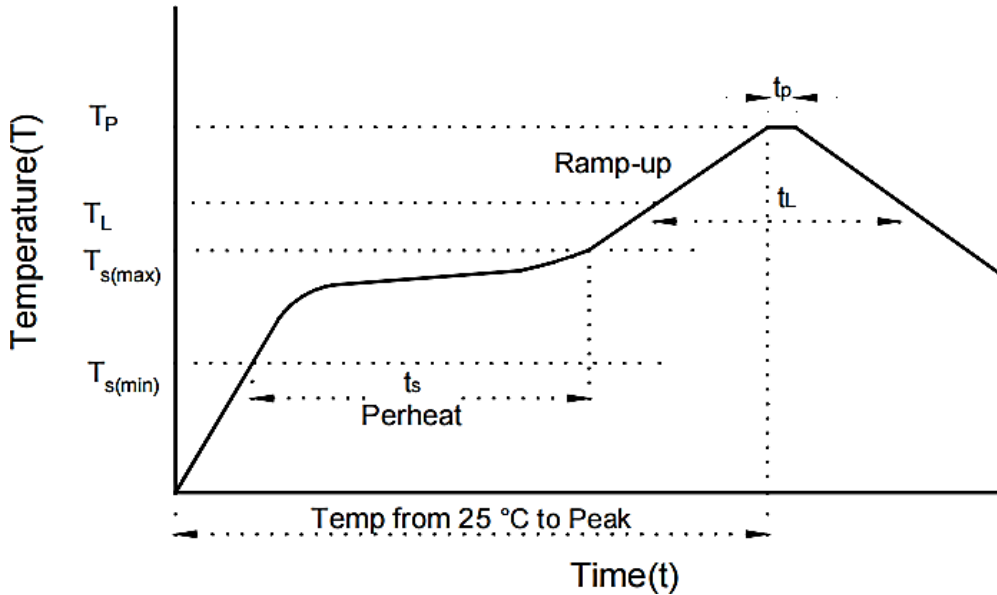

Fig. 4 Typical Capacitance vs. Reverse Voltage



SUGGESTED REFLOW PROFILE - For Reference Only



PROFILE FEATURE		PB-FREE ASSEMBLY
Average Ramp-up Rate (T_L Max to T_p)		3°C/second Max
Preheat	Temperature Min (T_s Min.)	150°C
	Temperature Max (T_s Max.)	200°C
	Time (t_s Min. to t_s Max.)	60 ~ 180 seconds
Time maintained above	Temperature (T_L)	217°C
	Time (t_L)	60 ~ 150 seconds
Peak/Classification Temperature (T_p)		260 °C
Time within 5°C of actual Peak Temperature (t_p)		10 seconds Max.
Ramp-down Rate		6 °C /Second Max.
Time 25 °C to Peak Temperature		8 Minutes Max.
Suggest reflow times		3 Times Max.

TAPE/REEL - Unit: mm, All Devices are packed in accordance with EIA standard RS-481-A and specifications

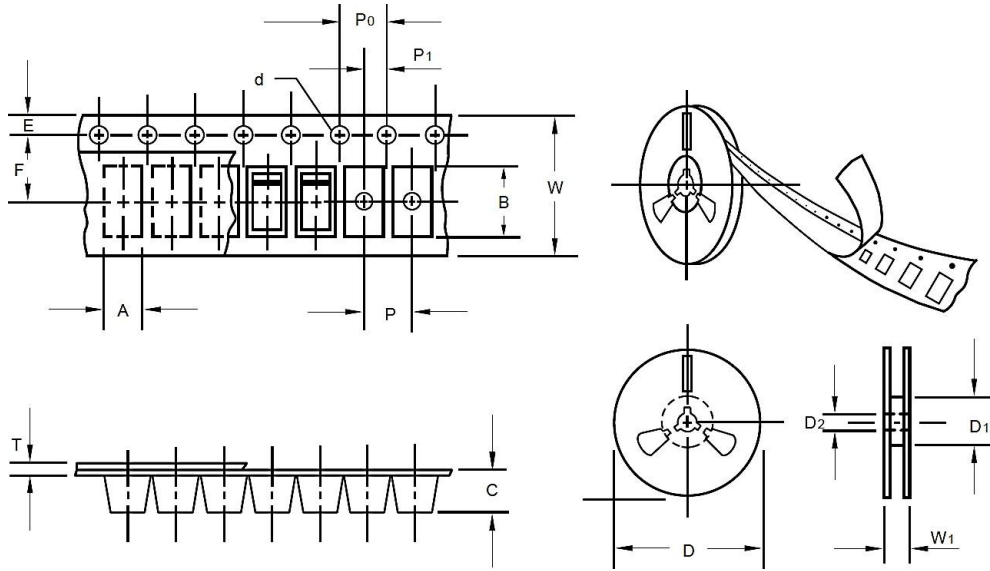

ITEM	SYMBOL	TOLERANCE	SOD-523
Carrier width	A	0.1	2.10
Carrier Length	B	0.1	4.00
Carrier Depth	C	0.1	1.60
Sprocket hole	d	0.05	1.55
7"Reel outside diameter	D	2	178
7"Reel inner diameter	D1	Min.	50
Feed hole diameter	D2	0.5	13
Sprocket hole position	E	0.1	1.75
Punch hole position	F	0.1	3.5
Punch hole pitch	P	0.1	4
Sprocket hole pitch	P0	0.1	4
Embossment center	P1	0.1	2
Overall tape thickness	T	0.1	0.25
Tape width	W	0.3	8.15
Reel width	W1	1	10.50
Qty. Per Reel (pcs)		3000	

IMPORTANT NOTES AND DISCLAIMER

- **RoHS Compliance:** This product complies with the requirements of EU RoHS Directive (EU) 2015/863 (RoHS 3). The concentration levels of RoHS-restricted substances are below the maximum permitted threshold limits, or the substances are used in applications exempted under the directive. A RoHS Test Report for this product is available through the Download Center.
- **REACH Compliance:** Information regarding REACH Substances of Very High Concern (SVHCs) is available for this product. As the European Chemicals Agency (ECHA) may revise the SVHC list periodically, the latest REACH information and test reports can be obtained from the Download Center.
- **Product Performance:** All product parametric performance data is specified under the electrical characteristics and corresponding test conditions listed herein, unless otherwise noted. Product performance may differ if the device is operated outside the specified conditions.
- **Specifications and Changes:** NextGen Components, Inc. ("*NextGen*") reserves the right to make changes to this document, as well as to its products and specifications, at any time without prior notice. Customers are responsible for obtaining and verifying the most current product information prior to final design, purchase, or use.
- **Warranty and Limitation of Liability:** *NextGen* makes no warranty, representation, or guarantee regarding the suitability of its products for any particular purpose and assumes no liability for application assistance or customer product design. NextGen shall not be responsible for, nor accept liability arising from, the use of its products in unintended, unauthorized, or improper applications. No license, express or implied, is granted under any intellectual property rights of *NextGen*.
- **Restricted Applications:** *NextGen* products are not authorized for use as critical components in life-support devices or systems, or in other safety-critical applications, without express written approval from *NextGen*.
- **Returns Policy:** Customers must obtain a Returned Merchandise Authorization (RMA) number prior to returning any products. Returns must be requested within 30 days from the invoice date and must be in original packaging, unused, and in like-new condition. Products designated as Non-Cancelable / Non-Returnable (NCNR) at the time of quotation or purchase are not eligible for return or refund.