

SPECIFICATION SHEET NO.	T0213- UZ227M6V3HEHTA	
ORIGINAL MFG/PART NO.	<b>Aillen</b> Aillen Capacitors/CAE227M0JHUZEE4TRC	
NEXTGEN PART CODE	UZ227M6V3HEHTA	Indicate This Code For <a href="#">RFQ</a> /Order
DATE	Feb. 13, 2026	
REVISION	A3	Updated With Most Recent Data
DESCRIPTION AND MAIN PARAMETRICS	<p>Aluminum Electrolytic Capacitors (CAE), SMD Type, UZ Series, 2 Pads Wide Temperature and Low Impedance Capacitance 220<math>\mu</math>F, Tolerance <math>\pm</math>20%, Voltage 6.3V Case size: <math>\varnothing</math>6.30*L5.40mm, Impedance (<math>\Omega</math>/20<math>^{\circ}</math>C,100KHz): 0.36<math>\Omega</math> Max. Ripple Current (mA r.m.s./@+105<math>^{\circ}</math>C, 100KHz): 240mA Max. Lifetime @105<math>^{\circ}</math>C <math>\pm</math>2: 2000 Hours Operating Temp. Range -55<math>^{\circ}</math>C ~+105<math>^{\circ}</math>C Package in Tape/Reel, 1000pcs/Reel REACH/RoHS Compliant, RoHS Directive2011/65/EU with amendment (EU) 2015/863 &amp; Halogen Free</p>	
CUSTOMER		
CUSTOMER PART NO.		
CROSS REF. PART NO.		
MEMO		

VENDOR APPROVE			
Issued/Checked/Approved			
Date: Feb. 13, 2026			

CUSTOMER APPROVE	
Date:	

## MAIN FEATURES

- Aluminum electrolytic capacitors, foil type
- Radial lead, can-type construction for surface mount applications
- Wide operating temperature range
- High reliability and stable electrical characteristics
- Designed to meet the requirements of IEC 60384
- Operating temperature range:  $-55^{\circ}\text{C}$  to  $+105^{\circ}\text{C}$
- Rated voltage range: up to 80 V
- Capacitance range: up to 1500  $\mu\text{F}$
- Endurance: 2000 hours at  $105^{\circ}\text{C}$
- Suitable as quality alternative parts to major manufacturers including KEMET, CHEMI-CON, NICHICON, RUBYCON, etc.
- Moisture Sensitivity Level: MSL 1 (Unlimited)
- RoHS compliant per Directive 2011/65/EU and amendment (EU) 2015/863
- REACH compliant and halogen-free



*Image shown is a representation only. Exact specifications should be obtained from the product dimension.*



## APPLICATIONS

- High-density surface mount circuits, such as: Power supply circuits/Lighting equipment
- Industrial equipment, including: Routers/Network switches/Measuring/Control instruments
- Consumer electronics, including: Audio amplifier circuits/Smoothing circuits/LED lighting

## ELECTRICAL CHARACTERISTICS

- Electrical characteristics for individual part numbers are shown on Page 8 to 15
- Specifications are subject to change without prior notice due to product improvement, safety, or technical considerations. Customers are advised to confirm the latest specifications with NextGen Components prior to use
- All product parameters are subject to final confirmation by NextGen Components.

**HOW TO ORDER**

- Please Follow Up Part Code Guide And Indicate NextGen Order Part Code UZ227M6V3HEHTA For RFQ/Order.

**RFQ**  
Request For Quotation

**PART CODE GUIDE**

CODE	NAME	KEY SPECIFICATION OPTION
UZ	Product Index	Aluminum Electrolytic Capacitors(CAE), V-Chip Type, Original MFG Series Number CDUZ
227	Rated Capacitance	475: 4.7μF; 105: 1.0μF; 106: 10μF; 156: 15μF; 225: 2.2μF; 226: 22μF; 276: 27μF; 336: 33μF; 476: 47μF; 566: 56μF; 686: 68μF; 107: 100μF; 157: 150μF; 227: 220μF 337: 330μF; 477: 470μF; 687: 680μF; 108: 1000μF; 158: 1500μF
M	Capacitance Tolerance	M: ±20% (Standard)
6V3	Rated Voltage	6V3: 6.3V; 010: 10V; 016:16V; 025: 25V; 035: 35V; 050: 50V; 063: 63V; 080: 80V; 100: 100V
H	Environmental Requirements	H: REACH/RoHS Compliant, RoHS Directive2011/65/EU with amendment (EU) 2015/863 & Halogen Free
E	Case Diameter	C: Ø4.0mm; D: Ø5.0mm; E: Ø6.3mm; F: Ø8.0mm; G: Ø10.0mm
H	Case Length	H: L5.4mm; I: L6.5mm; J: L7.7mm; K: L10.2mm
T	Package	T: Tape and Reel
A	Internal Control Code	Letter A~Z, a~z or digits (0~9)
XX	Suffix	Blank: N/A XX: Letter A~Z, a~z or digits (0~9) for Special/Custom Parameters

DIMENSION (Unit: mm )  $\phi D4.0 \sim \phi D6.3$  Non explosion proof valve;  $\phi D8.0 \sim \phi D10$  Explosion proof valve

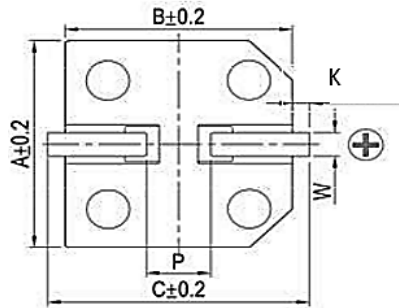
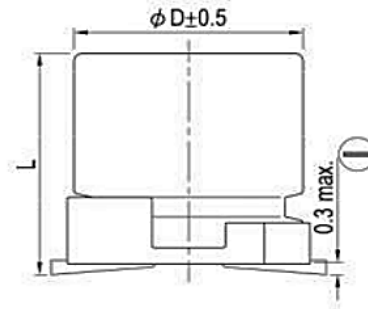

$\phi D$	4.0	5.0	6.3	6.3	8.0	8.0	10.0
Case L	5.4 $\pm$ 0.5	5.4 $\pm$ 0.5	5.4 $\pm$ 0.5	7.7 $\pm$ 0.5	6.5 $\pm$ 0.5	10.2 $\pm$ 0.5	10.2 $\pm$ 0.5
A	4.3	5.3	6.6	6.6	8.3	8.3	10.3
B	4.3	5.3	6.6	6.6	8.3	8.3	10.3
C	5.1	6.1	7.3	7.3	9.2	9.2	11.2
P	1.0 $\pm$ 0.2	1.5 $\pm$ 0.2	2.1 $\pm$ 0.2	2.1 $\pm$ 0.2	3.1 $\pm$ 0.2	3.1 $\pm$ 0.2	4.5 $\pm$ 0.2
K	0.5 Max.	0.5 Max.	0.5 Max.	0.5 Max.	0.5 Max.	0.5 Max.	0.5 Max.
W	0.5~0.9	0.5~0.9	0.5~0.9	0.5~0.9	0.8~1.1	0.8~1.1	0.8~1.1

MARKING GUIDE – FOR DIFFERENT ONLY



SYMBOL	NAME	VALUE	MARKING
①	Rated Capacitance	220 $\mu$ F	220
②	Rated Voltage	6.3V	6.3V
③	Series Code		UZ

RECOMMENDED LAND PATTERN (Unit: mm)

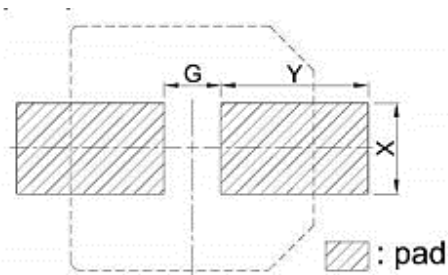

DIAMETER SIZE	X	Y	G
$\varnothing 4$	1.6	2.6	1.0
$\varnothing 5$	1.6	3.0	1.4
$\varnothing 6.3$	1.6	3.5	1.9
$\varnothing 8$	2.5	3.5	3.0
$\varnothing 10$	2.5	4.0	4.0

CONSTRUCTION – FOR REFERENCE ONLY

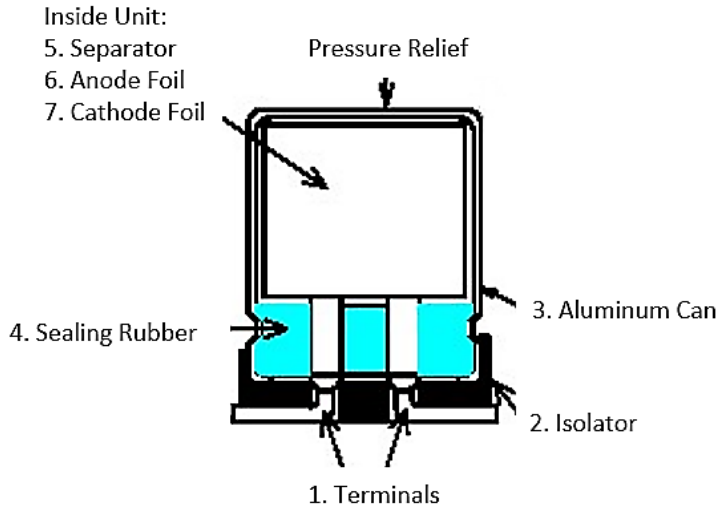

NO.	PARTS	MATERIAL
1	Terminal	Tinned Copper – Clad Steel Wire (Pb Free)
2	Isolator	Thermo-plastic resin
3	Aluminum Can	Aluminum
4	Sealing Rubber	Synthetic rubber
5	Separator	Manila hemp
6	Anode Foil	High purity aluminum foil
7	Cathode Foil	Aluminum foil

GENERAL ELECTRICAL CHARACTERISTICS – FOR DIFFERENT PART CODE

PARAMETER	UNITS	VALUE
Operating Junction Temperature Range	°C	-55 ~ +105
Storage Temperature Range	°C	-55 ~ +150
Lifetime @105°C ±2	Hours	2000

FREQUENCY COEFFICIENT OF ALLOWABLE RIPPLE CURRENT

Frequency	50Hz	120Hz	300Hz	1KHz	≥10KHz
Coefficient	0.64	0.70	0.75	0.83	1.00

TEMPERATURE COEFFICIENT

AMBIENT TEMPERATURE (°C)	105	85	≤70
Coefficient	1	1.5	2

ELECTRICAL CHARACTERISTICS - Ta = 25°C, FOR DIFFERENT PART CODE

NEXTGEN ORDER PART CODE	RATE VOL.	CAPACITOR VALUE	MAX.DF @20°C, 120HZ	MAX. LEAKAGE CURRENT	MAX. IMPEDANCE @20 °C 100KHZ	MAX. RIPPLE CURRENT @ 105°C 100KHZ	CASE SIZE ØD X L
	V	µF	%	µA	Ω	mA r.m.s	mm
UZ226M6V3HCHTA	6.3	22	26	3	1.35	90	4x5.4
UZ336M6V3HCHTA	6.3	33	26	3	1.35	90	4x5.4
UZ476M6V3HDHTA	6.3	47	26	3	0.7	160	5x5.4
UZ686M6V3HEHTA	6.3	68	26	4.28	0.36	240	6.3x5.4
UZ107M6V3HDHTA	6.3	100	26	6.3	0.7	160	5x5.4
UZ107M6V3HEHTA	6.3	100	26	6.3	0.36	240	6.3x5.4
UZ157M6V3HEHTA	6.3	150	26	9.45	0.36	240	6.3x5.4
<b>UZ227M6V3HEHTA</b>	6.3	220	26	13.86	0.36	240	6.3x5.4
UZ337M6V3HEJTA	6.3	330	26	20.79	0.32	290	6.3x7.7
UZ337M6V3HFKTA	6.3	330	26	20.79	0.17	450	8x10.2
UZ477M6V3HEJTA	6.3	470	26	29.61	0.32	290	6.3x7.7
UZ477M6V3HFKTA	6.3	470	26	29.61	0.17	450	8x10.2
UZ687M6V3HFKTA	6.3	680	26	42.84	0.17	450	8x10.2
UZ687M6V3HGKTA	6.3	680	26	42.84	0.16	600	10x10.2
UZ827M6V3HFKTA	6.3	820	26	51.66	0.17	450	8x10.2
UZ108M6V3HFKTA	6.3	1000	26	63	0.17	450	8x10.2
UZ108M6V3HGKTA	6.3	1000	26	63	0.16	600	10x10.2
UZ158M6V3HGKTA	6.3	1500	26	94.5	0.16	600	10x10.2

ELECTRICAL CHARACTERISTICS - Ta = 25°C, FOR DIFFERENT PART CODE

NEXTGEN ORDER PART CODE	RATE VOL.	CAPACITOR VALUE	MAX.DF @20°C, 120HZ	MAX. LEAKAGE CURRENT	MAX. IMPEDANCE @20 °C 100KHZ	MAX. RIPPLE CURRENT @ 105°C 100KHZ	CASE SIZE ØD X L
	V	µF	%	µA	Ω	mA r.m.s	mm
UZ226M010HCHTA	10	22	19	3	1.35	90	4x5.4
UZ336M010HDHTA	10	33	19	3.3	0.7	160	5x5.4
UZ476M010HEHTA	10	47	19	4.7	0.36	240	6.3x5.4
UZ686M010HEHTA	10	68	19	6.8	0.36	240	6.3x5.4
UZ107M010HEHTA	10	100	19	10	0.36	240	6.3x5.4
UZ157M010HEHTA	10	150	19	15	0.36	240	6.3x5.4
UZ227M010HEJTA	10	220	19	22	0.32	290	6.3x7.7
UZ337M010HEJTA	10	330	19	33	0.32	290	6.3x7.7
UZ337M010HFKTA	10	330	19	33	0.17	450	8x10.2
UZ477M010HEJTA	10	470	19	47	0.32	290	6.3x7.7
UZ477M010HFKTA	10	470	19	47	0.17	450	8x10.2
UZ687M010HFKTA	10	680	19	68	0.17	450	8x10.2
UZ687M010HGKTA	10	680	19	68	0.16	600	10x10.2
UZ108M010HFKTA	10	1000	19	100	0.17	450	8x10.2
UZ108M010HGKTA	10	1000	19	100	0.16	600	10x10.2

ELECTRICAL CHARACTERISTICS - Ta = 25°C, FOR DIFFERENT PART CODE

NEXTGEN ORDER PART CODE	RATE VOL.	CAPACITOR VALUE	MAX.DF @20°C, 120HZ	MAX. LEAKAGE CURRENT	MAX. IMPEDANCE @20 °C 100KHZ	MAX. RIPPLE CURRENT @ 105°C 100KHZ	CASE SIZE ØD X L
	V	µF	%	µA	Ω	mA r.m.s	mm
UZ106M016HCHTA	16	10	16	3	1.35	90	4x5.4
UZ226M016HDHTA	16	22	16	3.52	0.7	160	5x5.4
UZ336M016HEHTA	16	33	16	5.28	0.36	240	6.3x5.4
UZ476M016HDHTA	16	47	16	7.52	0.7	160	5x5.4
UZ476M016HEHTA	16	47	16	7.52	0.36	240	6.3x5.4
UZ686M016HEHTA	16	68	16	10.88	0.36	240	6.3x5.4
UZ107M016HEHTA	16	100	16	16	0.36	240	6.3x5.4
UZ157M016HEJTA	16	150	16	24	0.32	290	6.3x7.7
UZ227M016HEJTA	16	220	16	35.2	0.32	290	6.3x7.7
UZ227M016HFKTA	16	220	16	35.2	0.17	450	8x10.2
UZ337M016HFKTA	16	330	16	52.8	0.17	450	8x10.2
UZ477M016HFKTA	16	470	16	75.2	0.17	450	8x10.2
UZ477M016HGKTA	16	470	16	75.2	0.16	600	10x10.2
UZ687M016HGKTA	16	680	16	108.8	0.16	600	10x10.2



ELECTRICAL CHARACTERISTICS - Ta = 25°C, FOR DIFFERENT PART CODE

NEXTGEN ORDER PART CODE	RATE VOL.	CAPACITOR VALUE	MAX.DF @20°C, 120HZ	MAX. LEAKAGE CURRENT	MAX. IMPEDANCE @20 °C 100KHZ	MAX. RIPPLE CURRENT @ 105°C 100KHZ	CASE SIZE ØD X L
	V	µF	%	µA	Ω	mA r.m.s	mm
UZ475M035HCHTA	35	4.7	12	3	1.35	90	4x5.4
UZ106M035HDHTA	35	10	12	3.5	0.7	160	5x5.4
UZ226M035HEHTA	35	22	12	7.7	0.36	240	6.3x5.4
UZ336M035HEHTA	35	33	12	11.55	0.36	240	6.3x5.4
UZ476M035HEHTA	35	47	12	16.45	0.36	240	6.3x5.4
UZ476M035HEJTA	35	47	12	16.45	0.32	290	6.3x7.7
UZ686M035HEJTA	35	68	12	23.8	0.32	290	6.3x7.7
UZ107M035HEJTA	35	100	12	35	0.32	290	6.3x7.7
UZ107M035HFKTA	35	100	12	35	0.17	450	8x10.2
UZ157M035HFKTA	35	150	12	52.5	0.17	450	8x10.2
UZ157M035HGKTA	35	150	12	52.5	0.16	600	10x10.2
UZ227M035HFKTA	35	220	12	77	0.17	450	8x10.2
UZ227M035HGKTA	35	220	12	77	0.16	600	10x10.2
UZ337M035HGKTA	35	330	12	115.5	0.16	600	10x10.2

ELECTRICAL CHARACTERISTICS - Ta = 25°C, FOR DIFFERENT PART CODE

NEXTGEN ORDER PART CODE	RATE VOL.	CAPACITOR VALUE	MAX.DF @20°C, 120HZ	MAX. LEAKAGE CURRENT	MAX. IMPEDANCE @20 °C 100KHZ	MAX. RIPPLE CURRENT @ 105°C 100KHZ	CASE SIZE ØD X L
	V	µF	%	µA	Ω	mA r.m.s	mm
UZ225M050HCHTA	50	2.2	10	3	2.9	60	4x5.4
UZ335M050HCHTA	50	3.3	10	3	2.9	60	4x5.4
UZ475M050HCHTA	50	4.7	10	3	2.9	60	4x5.4
UZ106M050HDHTA	50	10	10	5	2.2	70	5x5.4
UZ106M050HEHTA	50	10	10	5	0.88	165	6.3x5.4
UZ226M050HEHTA	50	22	10	11	0.86	170	6.3x5.4
UZ336M050HEJTA	50	33	10	16.5	0.68	185	6.3x7.7
UZ476M050HEJTA	50	47	10	23.5	0.68	185	6.3x7.7
UZ476M050HGKTA	50	47	10	23.5	0.35	600	10x10.2
UZ107M050HEJTA	50	100	10	50	0.68	185	6.3x7.7
UZ107M050HFKTA	50	100	10	50	0.34	369	8x10.2
UZ157M050HGKTA	50	150	10	75	0.25	450	10x10.2
UZ227M050HGKTA	50	220	10	110	0.25	450	10x10.2





## CHARACTERISTICS

### Standard Atmospheric Conditions

The standard range of atmospheric conditions for making measurements/test as follows:

- Ambient temperature: 15 °C to 35 °C
- Relative humidity: 45% to 85%
- Air Pressure: 86kPa to 106kPa
- If there is any doubt about the results, measurement shall be made within the following conditions:
- Ambient temperature: 20 °C  $\pm$  2 °C
- Relative humidity: 60% to 70%
- Air Pressure: 86kPa to 106kPa
- As to the detailed information, please refer to following Table

### Operating Temperature Range

The ambient temperature range at which the capacitor can be operated continuously at rated voltage is -55 °C to 105 °C.

As to the detailed information, please refer to the mentioned table next pages.

ITEM	PERFORMANCE																		
Nominal Capacitance (Tolerance)	<p>&lt;Condition&gt;</p> <p>Measuring Frequency : 120Hz ± 12Hz</p> <p>Measuring Voltage : Not more than 0.5V</p> <p>Measuring Temperature : 20 ± 2°C</p> <p>&lt;Criteria&gt;</p> <p>Shall be within the specified capacitance tolerance</p>																		
Leakage Current	<p>&lt;Condition&gt;</p> <p>After DC Voltage is applied to capacitors through the series protective resistor (1kΩ ± 10Ω) so that terminal voltage may reach the reacted use voltage. The leakage current when measured in 2 minutes shall not exceed the values of the following equation.</p> <p>&lt;Criteria&gt;</p> <p><math>I (\mu A) \leq 0.01 CV</math> or 3 (μA), Whichever is greater</p> <p>I: Leakage Current (μA)</p> <p>C: Capacitance (μF)</p> <p>V: Rated Working Voltage (V)</p>																		
tan δ	<p>&lt;Condition&gt;</p> <p>See Normal Capacitance, for measuring frequency, voltage and temperature.</p> <p>&lt;Criteria&gt;</p> <p>The tangent of the loss angle (tan δ) of the capacitors shall refer to the following table. Measurements shall be made under the same conditions as those given for the measurement of the capacitance.</p> <table border="1" data-bbox="416 1411 1276 1516"> <tr> <td>W.V.</td> <td>6.3</td> <td>10</td> <td>16</td> <td>25</td> <td>35</td> <td>50</td> <td>63</td> <td>80</td> </tr> <tr> <td>Tanδ</td> <td>0.26</td> <td>0.19</td> <td>0.16</td> <td>0.14</td> <td>0.12</td> <td>0.10</td> <td>0.09</td> <td>0.09</td> </tr> </table> <p>Remark: Refer to this document for tan δ of other voltages.</p> <p>For capacitance value &gt; 1000μF, add 0.02 per another 1000μF on the basis of standard Tanδ.</p>	W.V.	6.3	10	16	25	35	50	63	80	Tanδ	0.26	0.19	0.16	0.14	0.12	0.10	0.09	0.09
W.V.	6.3	10	16	25	35	50	63	80											
Tanδ	0.26	0.19	0.16	0.14	0.12	0.10	0.09	0.09											
Rated voltage (WV) Surge voltage (SV)	<table border="1" data-bbox="416 1742 1092 1914"> <tr> <td>W.V. (V.DC)</td> <td>6.3</td> <td>10</td> <td>16</td> <td>25</td> <td>35</td> <td>50</td> </tr> <tr> <td>S.V. (V.DC.)</td> <td>7.2</td> <td>11.5</td> <td>18.4</td> <td>28.8</td> <td>40.2</td> <td>57.5</td> </tr> </table>	W.V. (V.DC)	6.3	10	16	25	35	50	S.V. (V.DC.)	7.2	11.5	18.4	28.8	40.2	57.5				
W.V. (V.DC)	6.3	10	16	25	35	50													
S.V. (V.DC.)	7.2	11.5	18.4	28.8	40.2	57.5													

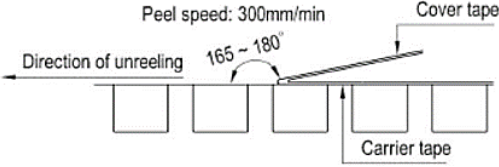
ITEM	PERFORMANCE																																													
Temperature Characteristic IEC-60384-4 4.12	<p>&lt;Condition&gt;</p> <table border="1" data-bbox="404 385 1300 689"> <thead> <tr> <th>Step.</th> <th>Testing Temperature(°C)</th> <th>Time</th> </tr> </thead> <tbody> <tr> <td>1</td> <td>20±2</td> <td>Time to reach thermal equilibrium</td> </tr> <tr> <td>2</td> <td>-55(-25) ±3</td> <td>Time to reach thermal equilibrium</td> </tr> <tr> <td>3</td> <td>20±2</td> <td>Time to reach thermal equilibrium</td> </tr> <tr> <td>4.</td> <td>105±2</td> <td>Time to reach thermal equilibrium</td> </tr> <tr> <td>5</td> <td>20±2</td> <td>Time to reach thermal equilibrium</td> </tr> </tbody> </table> <p>&lt;Criteria&gt;</p> <p>a) At +105°C, capacitance shall be within ±20% of their origin at +20°C, measured capacitance, tan δ shall be within limit of tan δ. The leakage current value at +105°C shall not more than 8 times the specified value.</p> <p>b) At step 5, tan δ shall be within the limit of tan δ. The leakage current value shall not more than the specified value.</p> <p>c) At -55°C (-25°C), impedance (Z) ratio shall not exceed the value of the following table.</p> <table border="1" data-bbox="444 1094 1300 1332"> <thead> <tr> <th>Rated Voltage (V)</th> <th>6.3</th> <th>10</th> <th>16</th> <th>25</th> <th>35</th> <th>50</th> <th>63</th> <th>80</th> </tr> </thead> <tbody> <tr> <td>Z-25°C/Z+20°C (120Hz)</td> <td>4</td> <td>3</td> <td>2</td> <td>2</td> <td>2</td> <td>2</td> <td>2</td> <td>2</td> </tr> <tr> <td>Z-55°C/Z+20°C (120Hz)</td> <td>8</td> <td>6</td> <td>4</td> <td>4</td> <td>3</td> <td>3</td> <td>3</td> <td>4</td> </tr> </tbody> </table> <p>d) Capacitance tan δ and impedance shall be measured at 120Hz</p>	Step.	Testing Temperature(°C)	Time	1	20±2	Time to reach thermal equilibrium	2	-55(-25) ±3	Time to reach thermal equilibrium	3	20±2	Time to reach thermal equilibrium	4.	105±2	Time to reach thermal equilibrium	5	20±2	Time to reach thermal equilibrium	Rated Voltage (V)	6.3	10	16	25	35	50	63	80	Z-25°C/Z+20°C (120Hz)	4	3	2	2	2	2	2	2	Z-55°C/Z+20°C (120Hz)	8	6	4	4	3	3	3	4
Step.	Testing Temperature(°C)	Time																																												
1	20±2	Time to reach thermal equilibrium																																												
2	-55(-25) ±3	Time to reach thermal equilibrium																																												
3	20±2	Time to reach thermal equilibrium																																												
4.	105±2	Time to reach thermal equilibrium																																												
5	20±2	Time to reach thermal equilibrium																																												
Rated Voltage (V)	6.3	10	16	25	35	50	63	80																																						
Z-25°C/Z+20°C (120Hz)	4	3	2	2	2	2	2	2																																						
Z-55°C/Z+20°C (120Hz)	8	6	4	4	3	3	3	4																																						
Sealing Tape Reel Strength	<p>&lt;Condition&gt;</p> <p>Peel angle: 165 to 180°C referred to the surface on which the tape is glued.</p> <p>Peel speed: 300mm per minutes</p> <p>The peel strength must be 0.1 ~ 0.7N under these conditions.</p> 																																													

ITEM	PERFORMANCE										
<p>Load Life Test IEC-60384- 4 4.13</p>	<p>&lt;Condition&gt; The capacitor is stored at a temperature of 105° C ±2 with rated voltage applied continuously for 2000+48/0 hours, Then the product should be tested after 16 hours recovering time at atmospheric conditions. The result should meet the following table: &lt;Criteria&gt; The characteristic shall meet the following requirements.</p> <table border="1" data-bbox="401 623 1278 909"> <tr> <td>Capacitance Change</td> <td>± 30% of initial measured value.</td> </tr> <tr> <td>tan δ</td> <td>300% or less of the specified value</td> </tr> <tr> <td>Leakage current</td> <td>Not more than the specified value.</td> </tr> <tr> <td>Appearance</td> <td>No leakage of electrolyte or swelling of the case. All markings shall be legible</td> </tr> <tr> <td>Inner construction</td> <td>No corrosion of tab terminals or electrodes</td> </tr> </table> <p>Remarks: Prior to the measurement of the leakage current, the D.C. rated voltage shall be applied across the capacitor and its protective resistance (1kΩ) for 30 mins after which it shall be discharged.</p>	Capacitance Change	± 30% of initial measured value.	tan δ	300% or less of the specified value	Leakage current	Not more than the specified value.	Appearance	No leakage of electrolyte or swelling of the case. All markings shall be legible	Inner construction	No corrosion of tab terminals or electrodes
Capacitance Change	± 30% of initial measured value.										
tan δ	300% or less of the specified value										
Leakage current	Not more than the specified value.										
Appearance	No leakage of electrolyte or swelling of the case. All markings shall be legible										
Inner construction	No corrosion of tab terminals or electrodes										
<p>Shelf Life Test IEC-60384- 4 4.17</p>	<p>&lt;Condition&gt; The capacitors are then stored with no voltage applied at a temperature of 105 ±2°C for 1000+48/0 hours. Following this period the capacitors shall be removed from the test chamber and be allowed to stabilize at room temperature for 4~8 hours. Next they shall be connected to a series limiting resistor(1k±100Ω) with D.C. rated voltage applied for 30min. After which the capacitors shall be discharged, and then, tested the characteristics. &lt;Criteria&gt; The characteristic shall meet the following requirements.</p> <table border="1" data-bbox="401 1514 1278 1800"> <tr> <td>Capacitance Change</td> <td>± 30% of initial measured value.</td> </tr> <tr> <td>tan δ</td> <td>300% or less of the specified value</td> </tr> <tr> <td>Leakage current</td> <td>Not more than 200% of the specified value</td> </tr> <tr> <td>Appearance</td> <td>No leakage of electrolyte or swelling of the case. All markings shall be legible</td> </tr> <tr> <td>Inner construction</td> <td>No corrosion of tab terminals or electrodes</td> </tr> </table> <p>Remark: If the capacitors are stored more than 1 year, the leakage current may increase. Please apply voltage through about 1 KΩ resistor, if necessary.</p>	Capacitance Change	± 30% of initial measured value.	tan δ	300% or less of the specified value	Leakage current	Not more than 200% of the specified value	Appearance	No leakage of electrolyte or swelling of the case. All markings shall be legible	Inner construction	No corrosion of tab terminals or electrodes
Capacitance Change	± 30% of initial measured value.										
tan δ	300% or less of the specified value										
Leakage current	Not more than 200% of the specified value										
Appearance	No leakage of electrolyte or swelling of the case. All markings shall be legible										
Inner construction	No corrosion of tab terminals or electrodes										

ITEM	PERFORMANCE								
<p>Surge Test IEC-60384- 4 4.9</p>	<p>&lt;Condition&gt; Test temperature:15~35°C Series resistor: <math>R = \frac{100 \pm 50}{C}</math> R: protective resistor (KΩ) C: nominal capacitance (μF) Test voltage: Surge voltage item 4.4 No. of cycles: 1000cycles Each cycles lasts for <math>6 \pm 0.5</math>min “ON” for <math>30 \pm 5</math> s “OFF” for <math>5 \pm 0.5</math>min.</p> <table border="1" data-bbox="402 665 1285 870"> <tr> <td>Leakage current</td> <td>Not more than the specified value</td> </tr> <tr> <td>Capacitance Change</td> <td>Within <math>\pm 15\%</math> of initial value.</td> </tr> <tr> <td>tan δ</td> <td>Not more than the specified value.</td> </tr> <tr> <td>Appearance</td> <td>There shall be no leakage of electrolyte.</td> </tr> </table> <p>Attention: This test simulates over voltage at abnormal situation and not be hypothesizing that over voltage is always applied.</p>	Leakage current	Not more than the specified value	Capacitance Change	Within $\pm 15\%$ of initial value.	tan δ	Not more than the specified value.	Appearance	There shall be no leakage of electrolyte.
Leakage current	Not more than the specified value								
Capacitance Change	Within $\pm 15\%$ of initial value.								
tan δ	Not more than the specified value.								
Appearance	There shall be no leakage of electrolyte.								
<p>Vibration Test IEC-60384- 4 4.8</p>	<p>&lt;Condition&gt; Fix it at the point 4 mm or less from body. For ones of 12.5 mm or more in diameter or 25 mm or Capacitance; Direction and during of vibration:3 orthogonal directions mutually each for 2 hours(total of 6 hours) Vibration frequency range : 10Hz ~ 55Hz Peak to peak amplitude : 1.5mm Sweep rate : 10Hz ~ 55Hz ~ 10Hz in about 1 minute &lt;Criteria&gt; The characteristic shall meet the following requirements.</p> <table border="1" data-bbox="402 1524 1285 1730"> <tr> <td>Leakage current</td> <td>Not more than the specified value</td> </tr> <tr> <td>Capacitance Change</td> <td>Within <math>\pm 10\%</math> of initial value.</td> </tr> <tr> <td>tan δ</td> <td>Not more than the specified value.</td> </tr> <tr> <td>Appearance</td> <td>There shall be no leakage of electrolyte.</td> </tr> </table>	Leakage current	Not more than the specified value	Capacitance Change	Within $\pm 10\%$ of initial value.	tan δ	Not more than the specified value.	Appearance	There shall be no leakage of electrolyte.
Leakage current	Not more than the specified value								
Capacitance Change	Within $\pm 10\%$ of initial value.								
tan δ	Not more than the specified value.								
Appearance	There shall be no leakage of electrolyte.								

ITEM	PERFORMANCE								
<p>Solderability</p> <p>Test IEC-60384-4</p> <p>4.6</p>	<p>&lt;Condition&gt;</p> <p>The capacitor shall be tested under the following conditions:</p> <p>Soldering temperature: 245°C ± 3°C</p> <p>Dipping depth: 2mm</p> <p>Dipping speed: 25 ± 2.5mm/s</p> <p>Dipping time: 3 ± 0.5s</p> <p>&lt;Criteria&gt;</p> <table border="1" data-bbox="395 671 1253 754"> <tr> <td>Coating quality</td> <td>A minimum of 95% of the surface being immersed</td> </tr> </table>	Coating quality	A minimum of 95% of the surface being immersed						
Coating quality	A minimum of 95% of the surface being immersed								
<p>Resistance to solder heat test</p>	<p>&lt;Condition&gt;</p> <p>After reflow soldering (item 4.18)</p> <p>The capacitor shall be left at room temperature for before measurement.</p> <p>&lt;Criteria&gt;</p> <p>The characteristic shall meet the following requirements.</p> <table border="1" data-bbox="395 1073 1253 1276"> <tr> <td>Leakage current</td> <td>Not more than the specified value</td> </tr> <tr> <td>Capacitance Change</td> <td>Within ± 10% of initial value.</td> </tr> <tr> <td>tan δ</td> <td>Not more than the specified value.</td> </tr> <tr> <td>Appearance</td> <td>There shall be no leakage of electrolyte.</td> </tr> </table>	Leakage current	Not more than the specified value	Capacitance Change	Within ± 10% of initial value.	tan δ	Not more than the specified value.	Appearance	There shall be no leakage of electrolyte.
Leakage current	Not more than the specified value								
Capacitance Change	Within ± 10% of initial value.								
tan δ	Not more than the specified value.								
Appearance	There shall be no leakage of electrolyte.								
<p>Damp heat test</p> <p>IEC60384-4</p> <p>4.12</p>	<p>&lt;Condition&gt;</p> <p>Humidity Test:</p> <p>According to IEC60384-4 No.4.12 methods, capacitor shall be exposed for 1000±8 hours in an atmosphere of 90~95%R H .at 60±3°C, the characteristic change shall meet the following requirement.</p> <p>&lt;Criteria&gt;</p> <table border="1" data-bbox="395 1657 1253 1860"> <tr> <td>Leakage current</td> <td>Not more than the specified value</td> </tr> <tr> <td>Capacitance Change</td> <td>Within ± 20% of initial value.</td> </tr> <tr> <td>tan δ</td> <td>Not more than 120% of the specified value</td> </tr> <tr> <td>Appearance</td> <td>There shall be no leakage of electrolyte.</td> </tr> </table>	Leakage current	Not more than the specified value	Capacitance Change	Within ± 20% of initial value.	tan δ	Not more than 120% of the specified value	Appearance	There shall be no leakage of electrolyte.
Leakage current	Not more than the specified value								
Capacitance Change	Within ± 20% of initial value.								
tan δ	Not more than 120% of the specified value								
Appearance	There shall be no leakage of electrolyte.								

ITEM	PERFORMANCE																													
<p>Change Of Temperature Test IEC-60384-4 4.7</p>	<p>&lt;Condition&gt; Temperature cycle: According to IEC60384-4 No.4.7 methods, capacitor shall be placed in an oven, the condition according as below</p> <table border="1" data-bbox="402 480 1306 839"> <thead> <tr> <th>No.</th> <th>Temperature</th> <th>Time</th> </tr> </thead> <tbody> <tr> <td>1</td> <td>+25°C</td> <td>≤3 Minutes</td> </tr> <tr> <td>2</td> <td>-55°C</td> <td>30 ± 2 Minutes</td> </tr> <tr> <td>3</td> <td>+25°C</td> <td>≤3 Minutes</td> </tr> <tr> <td>4</td> <td>+105°C</td> <td>30 ± 2 Minutes</td> </tr> <tr> <td>5</td> <td>+25°C</td> <td>≤3 Minutes</td> </tr> <tr> <td colspan="3" style="text-align: center;">1 to 5 = 1 cycle, Total 5 cycles</td> </tr> </tbody> </table> <p>and then the capacitor shall be subjected to standard atmospheric conditions for 4 hours, after which measurements shall be made.</p> <p>&lt;Criteria&gt; The characteristic shall meet the following requirements.</p> <table border="1" data-bbox="402 1052 1300 1290"> <tbody> <tr> <td>Capacitance Change</td> <td>Within ± 10% of initial value.</td> </tr> <tr> <td>tan δ</td> <td>Not more than the specified value.</td> </tr> <tr> <td>Leakage current</td> <td>Not more than the specified value.</td> </tr> <tr> <td>Appearance</td> <td>No broken and undamaged.</td> </tr> </tbody> </table>	No.	Temperature	Time	1	+25°C	≤3 Minutes	2	-55°C	30 ± 2 Minutes	3	+25°C	≤3 Minutes	4	+105°C	30 ± 2 Minutes	5	+25°C	≤3 Minutes	1 to 5 = 1 cycle, Total 5 cycles			Capacitance Change	Within ± 10% of initial value.	tan δ	Not more than the specified value.	Leakage current	Not more than the specified value.	Appearance	No broken and undamaged.
No.	Temperature	Time																												
1	+25°C	≤3 Minutes																												
2	-55°C	30 ± 2 Minutes																												
3	+25°C	≤3 Minutes																												
4	+105°C	30 ± 2 Minutes																												
5	+25°C	≤3 Minutes																												
1 to 5 = 1 cycle, Total 5 cycles																														
Capacitance Change	Within ± 10% of initial value.																													
tan δ	Not more than the specified value.																													
Leakage current	Not more than the specified value.																													
Appearance	No broken and undamaged.																													
<p>Low Temperature Test</p>	<p>&lt;Condition&gt; Capacitors are placed at -55 ± 3°C for 96 ± 4 hours. And then the capacitor shall be subjected to standard atmospheric conditions for 4 hours, after which measurements shall be made.</p> <p>&lt;Criteria&gt;</p> <table border="1" data-bbox="402 1587 1282 1825"> <tbody> <tr> <td>Leakage current</td> <td>Not more than the specified value</td> </tr> <tr> <td>Capacitance Change</td> <td>Within ± 10% of initial value.</td> </tr> <tr> <td>tan δ</td> <td>Not more than the specified value.</td> </tr> <tr> <td>Appearance</td> <td>No broken and undamaged</td> </tr> </tbody> </table>	Leakage current	Not more than the specified value	Capacitance Change	Within ± 10% of initial value.	tan δ	Not more than the specified value.	Appearance	No broken and undamaged																					
Leakage current	Not more than the specified value																													
Capacitance Change	Within ± 10% of initial value.																													
tan δ	Not more than the specified value.																													
Appearance	No broken and undamaged																													

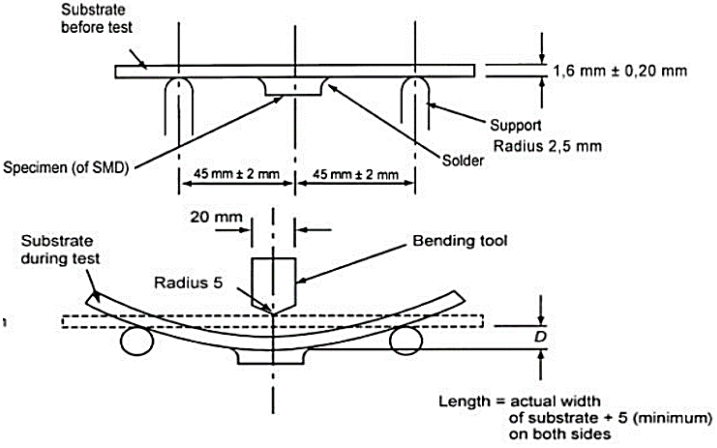
ITEM	PERFORMANCE				
<p>Vent Test IEC-60384-4 4.16</p>	<p>&lt;Condition&gt;</p> <p>The following test only apply to those products with vent products at diameter <math>\geq \varnothing 8</math> with vent.</p> <p>D.C. test</p> <p>The capacitor is connected with its polarity reversed to a DC power source. Then a current selected from following table is applied.</p> <table border="1" data-bbox="454 634 1168 737"> <thead> <tr> <th>Diameter (mm)</th> <th>DC Current (A)</th> </tr> </thead> <tbody> <tr> <td>22.4 or less</td> <td>1</td> </tr> </tbody> </table> <p>&lt;Criteria&gt;</p> <p>No emission of gas after 30 minutes of the voltage application also meets the specification. The vent shall operate with no dangerous conditions such as flames or dispersion of pieces of the capacitor and/or case.</p>	Diameter (mm)	DC Current (A)	22.4 or less	1
Diameter (mm)	DC Current (A)				
22.4 or less	1				
<p>Mechanical Characteristics Test</p>	<p>&lt;Condition&gt;</p> <p>Bending Test: Apply pressure in the direction of the arrow at a rate of about 0.5 mm/s until bent width reaches 2 mm and hold for 60s. The board shall be the test board "B" as specified in JIS C 0051: 2002. If the land area differs, it shall be specified clearly in the next item.</p>  <p>&lt;Criteria&gt;</p> <p>Without mechanical damage such as breaks. Electrical characteristics shall be satisfied.</p> <p>If there are electrodes on both surfaces, above requirements shall be satisfied on whichever surface it may be fixated on.</p>				

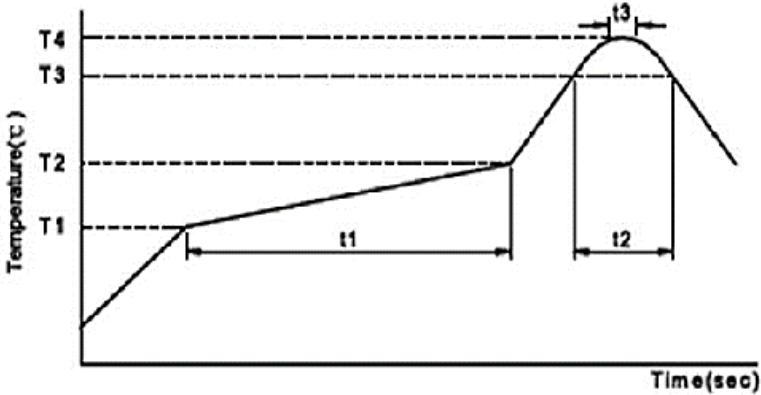
ITEM	PERFORMANCE			
Reflow Soldering  Temperature Profile	Welding Method	Reflow Soldering	Soldering Iron	Wave Soldering
	The feasibility of	○ Feasible	○ Feasible	✘ Is not workable
Conditions for the use of lead-free reflow soldering.				
				
<p>1) Methods the following            Reflow soldering: please follow the temperature condition during welding. If high temperature is used, please measure and inform the capacitor temperature and reflow soldering condition. The product size is larger and its rising temperature is slower. It is not necessary to adjust the temperature of the reflow solder in accordance with the size of the product. For example, the products of 4 and 10 will be installed in the PCB over tin furnace.</p> <p>2) Precautions for soldering tin: Related factors of reflow soldering temperature:            Product size: The product size is larger and its temperature rises slowly.            Product installation position: The temperature of PCB center is lower than that of PCB</p> <p>3) Reflow soldering            If possible, avoid reflow soldering twice.            If repeated reflux is unavoidable, measure and inform the first and second reflux temperature, and the time of reflow soldering</p> <p>4) Please do not 3 times of reflow soldering            Please follow the following conditions when soldering tin soldering:            Soldering iron maximum temperature: <math>350 \pm 5^{\circ}\text{C}</math>;            Welding time: 3+1/-0S</p>				

ITEM	PERFORMANCE																																																																													
Reflow Soldering  Temperature Profile	<p>Test Method And Peak Temperature Permissible Range</p> <table border="1" data-bbox="422 379 1276 779"> <thead> <tr> <th colspan="2" data-bbox="422 379 759 410">Products category</th> <th colspan="6" data-bbox="759 379 1276 410">SMD aluminum electrolytic capacitor</th> </tr> </thead> <tbody> <tr> <td data-bbox="422 410 759 441">voltage ( V )</td> <td data-bbox="759 410 848 441">4~50</td> <td data-bbox="848 410 982 441">4~50</td> <td data-bbox="982 410 1051 441">≥63</td> <td data-bbox="1051 410 1190 441">4~100</td> <td data-bbox="1190 410 1276 441">≥160</td> <td colspan="2"></td> </tr> <tr> <td data-bbox="422 441 759 524">Product size</td> <td data-bbox="759 441 848 524">Φ4~6.3 3×4.5 L</td> <td data-bbox="848 441 982 524">Φ4~6.3</td> <td data-bbox="982 441 1051 524">Φ4~6.3</td> <td data-bbox="1051 441 1190 524">Φ8~18</td> <td colspan="3" data-bbox="1190 441 1276 524">≥Φ12.5</td> </tr> <tr> <td data-bbox="422 524 556 555" rowspan="2">Preheating</td> <td data-bbox="556 524 759 555">TEM ( T<sub>1</sub>~T<sub>2</sub> , °C )</td> <td colspan="6" data-bbox="759 524 1276 555">150~180</td> </tr> <tr> <td data-bbox="556 555 759 586">Time ( t<sub>1</sub> ) Max, S</td> <td data-bbox="759 555 848 586">120</td> <td colspan="5" data-bbox="848 555 1276 586">180</td> </tr> <tr> <td data-bbox="422 586 556 617" rowspan="2">The duration of the</td> <td data-bbox="556 586 759 617">TEM ( T<sub>3</sub> , °C )</td> <td data-bbox="759 586 848 617">230</td> <td data-bbox="848 586 936 617">217</td> <td data-bbox="936 586 1025 617">230</td> <td data-bbox="1025 586 1113 617">217</td> <td data-bbox="1113 586 1202 617">217</td> <td data-bbox="1202 586 1276 617">230</td> </tr> <tr> <td data-bbox="556 617 759 648">Time ( t<sub>2</sub> ) Max, S</td> <td data-bbox="759 617 848 648">30</td> <td data-bbox="848 617 936 648">90</td> <td data-bbox="936 617 1025 648">60</td> <td data-bbox="1025 617 1113 648">60</td> <td data-bbox="1113 617 1202 648">60</td> <td data-bbox="1202 617 1276 648">40</td> </tr> <tr> <td data-bbox="422 648 556 679" rowspan="2">The highest temperature</td> <td data-bbox="556 648 759 679">TEM ( T<sub>4</sub> , °C )</td> <td data-bbox="759 648 848 679">250</td> <td colspan="2" data-bbox="848 648 982 679">260</td> <td data-bbox="982 648 1071 679">250</td> <td colspan="2" data-bbox="1071 648 1205 679">250</td> </tr> <tr> <td data-bbox="556 679 759 710">Time ( t<sub>3</sub> ) Max, S</td> <td colspan="6" data-bbox="759 679 1276 710">5</td> </tr> <tr> <td data-bbox="422 710 759 741">Return the number</td> <td data-bbox="759 710 848 741">1</td> <td colspan="6" data-bbox="848 710 1276 741">≤2</td> </tr> </tbody> </table> <ul style="list-style-type: none"> <li>• Please contact us if the conditions of use are higher than those listed above.</li> <li>• When performing second reflow soldering, please make sure the temperature of capacitor has cooled to 5 ~ 35 °C.</li> <li>• If the reflow condition is based on IPC/JEDEC(J-STD-020), please contact us.</li> </ul> <p>OP-CAP Precautions:</p> <ul style="list-style-type: none"> <li>• Reflow soldering will reduce the rated electrostatic capacity of the product, and it should be confirmed whether reflow soldering condition meets the specification of recommended reflow soldering.</li> <li>• Although the actual reflow condition change is still based on the reflow soldering method, please note that the highest temperature and the electrode terminal at the bottom of the aluminum shell must not exceed the maximum temperature.</li> <li>• OP-CAP products during the process of reflow heating temperature should increase to more than 200 °C</li> <li>• If the reflow condition temperature or duration is greater than the above table, the OP-CAP product will be damaged. The electrostatic capacity of the product is reduced by about 50%, the leakage current is large (up to mA), and the outside of the capacitor is damaged.</li> </ul> <p>Recommended Land Size (see page 5)</p>	Products category		SMD aluminum electrolytic capacitor						voltage ( V )	4~50	4~50	≥63	4~100	≥160			Product size	Φ4~6.3 3×4.5 L	Φ4~6.3	Φ4~6.3	Φ8~18	≥Φ12.5			Preheating	TEM ( T <sub>1</sub> ~T <sub>2</sub> , °C )	150~180						Time ( t <sub>1</sub> ) Max, S	120	180					The duration of the	TEM ( T <sub>3</sub> , °C )	230	217	230	217	217	230	Time ( t <sub>2</sub> ) Max, S	30	90	60	60	60	40	The highest temperature	TEM ( T <sub>4</sub> , °C )	250	260		250	250		Time ( t <sub>3</sub> ) Max, S	5						Return the number	1	≤2					
Products category		SMD aluminum electrolytic capacitor																																																																												
voltage ( V )	4~50	4~50	≥63	4~100	≥160																																																																									
Product size	Φ4~6.3 3×4.5 L	Φ4~6.3	Φ4~6.3	Φ8~18	≥Φ12.5																																																																									
Preheating	TEM ( T <sub>1</sub> ~T <sub>2</sub> , °C )	150~180																																																																												
	Time ( t <sub>1</sub> ) Max, S	120	180																																																																											
The duration of the	TEM ( T <sub>3</sub> , °C )	230	217	230	217	217	230																																																																							
	Time ( t <sub>2</sub> ) Max, S	30	90	60	60	60	40																																																																							
The highest temperature	TEM ( T <sub>4</sub> , °C )	250	260		250	250																																																																								
	Time ( t <sub>3</sub> ) Max, S	5																																																																												
Return the number	1	≤2																																																																												

TAPE (Unit: mm), Applicable standard JIS C0806 and IEC 60286.

Fig. 1 (Ø4)

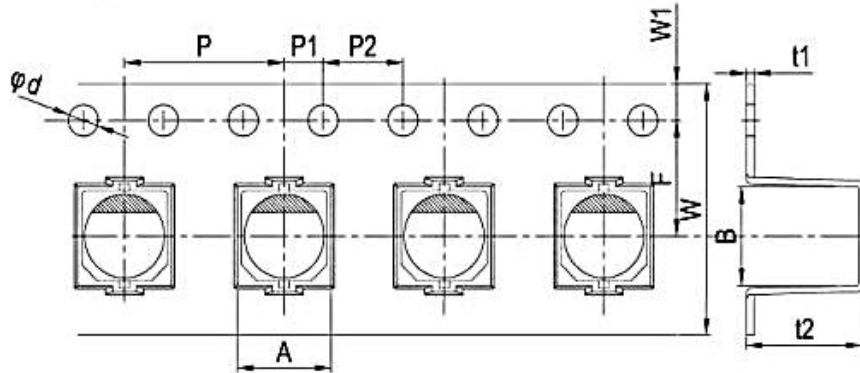

Fig. 2 (Ø5~Ø10)



SIZE	W	P	F	A0	B0	t2	Ød	P1	P2	t1	W1	APPLICABLE
Ø4*5.4	12	8	5.5	4.7	4.7	5.8	1.5	2	4	0.4	1.75	Fig.1-1
Ø5*5.4	12	12	5.5	6.0	6.0	5.8	1.5	2	4	0.4	1.75	Fig.1-2
Ø6.3*5.4	16	12	7.5	7.0	7.0	5.8	1.5	2	4	0.4	1.75	Fig.1-2
Ø6.3*7.7	16	12	7.5	7.0	7.0	8.3	1.5	2	4	0.4	1.75	Fig.1-2
Ø8*6.5	16	12	7.5	8.7	8.7	6.8	1.5	2	4	0.4	1.75	Fig.1-2
Ø8*10.2	24	16	11.5	8.7	8.7	11.0	1.5	2	4	0.4	1.75	Fig.1-2
Ø10*10.2	24	16	11.5	10.7	10.7	11.0	1.5	2	4	0.4	1.75	Fig.1-2

REEL (Unit: mm), Applicable standard JIS C0806 and IEC 60286.



CASE SIZE	Ø4	Ø5	Ø6.3	Ø8x6.5	Ø8x10.2	Ø10
W (mm)	14	14	18	18	26	26
Qty/Reel (pcs)	2000	1000	1000	500	500	500

**PACKING METHOD**

- Polarity: Anode on the opposite side of the feed hole
- The leader length of the tape shall not be less than 400mm including 10 or more embossed sections in which no parts are contained.
- The winding core is provided with an over 40mm long empty section



## APPLICATION GUIDELINE

### CIRCUIT DESIGN

1) Please make sure the environmental and mounting conditions to which the capacitor will be exposed are within the conditions specified in catalogue.

2) Operating temperature and applied ripple shall be within specification.

3) Appropriate capacitors which comply with the life requirement of the products should be selected when designing the circuit.

4) Aluminum electrolytic capacitors are polar. Make sure that no reverse voltage or AC voltage is applied to the capacitors. Please use bi-polar capacitors for a circuit that can possibly see reversed polarity.

Note: Even bi-polar capacitors cannot be used for AC voltage application.

5) Do not use aluminum electrolytic capacitors in a circuit that requires rapid and very frequent charge/ discharge. In this type of circuit, it is necessary to use a special design capacitor with extended life characteristics.

6) Do not apply excess voltage.

(1) Please pay attention to that the peak voltage, which is DC voltage overlapped by ripple current, will not exceed the rated voltage.

(2) In the case where more than 2 aluminum electrolytic capacitors are used in series, please make sure that applied voltage will be lower than rated voltage and the voltage will be applied to each capacitor equally by using a balancing resistor in parallel with the capacitor.

7) Aluminum electrolytic capacitors shall not be used under the following environmental conditions:

(1) (a) Capacitors will be exposed to water (including condensation), brine or oil. (b) Ambient conditions that include toxic gases such as hydrogen sulfide, sulfurous acid, nitrous acid, chlorine, bromine, methyl bromide, ammonium, etc. (c) Ambient conditions that expose the capacitor to ozone, ultraviolet ray and radiation.

(2) Severe vibration and physical shock conditions that exceed specification.

Vibration test condition: 10-55-10Hz

Vibration frequency range : 10~55~10hz

Sweep rate : 10~55~10Hz/minute

Sweep method : logarithmic

Amplitude or acceleration : 1.5mm (max. Acceleration is 10G)

Direction of vibration : X, Y, Z direction

Testing time: 2 hours per each direction

Shock is not applicable normally.

If a particular condition is required, please contact our sales team.

8) The main chemical solution of the electrolyte and the separator paper used in the capacitors are combustible.

The electrolyte is conductive. When it comes in contact with the PC board, there is a possibility of pattern corrosion or short circuit between the circuit pattern, which could result in smoking or catching fire. Do not locate any circuit pattern beneath the capacitor end seal.

9) Do not design a circuit board that the heat generating components are placed near the aluminum electrolytic capacitor or on the reverse side of PC board, if that just under the capacitor.

10) Electrical characteristics may vary depending on changes in temperature and frequency. Please consider this variation when you design circuits.

11) When you install more than 2 capacitors in parallel, please consider the balance of current flowing into the capacitors.

12) While mounting capacitors on double-side PC board, the capacitors should be away from those unnecessary base plate holes and connection holes.

#### MOUNTING

1) Once a capacitor has been assembled in the set and power applied, do not attempt to re-use the capacitor in other circuits or application.

2) Leakage current of the capacitors that have been stored for more than 2 years may increase. When leakage current has increased, please perform a voltage treatment using a 1kΩ resistor.

3) Please confirm specifications and polarity before installing capacitors on the PC board.

4) Do not drop capacitors on the floor, nor use a capacitor that was dropped.

5) Do not deform the capacitor during installation.

6) Please pay attention to the mechanical shock to the capacitor by suction nozzle of the automatic insertion machine or automatic mounter, or by product checker, or by centering mechanism.

#### REFLOW SOLDERING

1) Please follow "Reflow Soldering Conditions" when use the part.

2) When an infrared heater is used, please pay attention to the extent of heating since the absorption rate of infrared will vary due to difference in the color and size of the capacitor.

3) Do not tilt lay down or twist the capacitor body after the capacitor are soldered to the PC board.

4) Do not carry the PC board by grasping the soldered capacitor.

5) Please do not allow anything to touch the capacitor after soldering. If PC boards are stored in stack, please make sure the PC board or other components away from the capacitor.

6) The capacitors shall not be effected by any radiated heat from the soldered PC board or other components after soldering.

7) Cleaning:

(a) Do not clean capacitors with halogenated cleaning agent. However, if it is necessary to clean with halogenated cleaning agent, please contact our sales team.

(b) Recommended cleaning method

Applicable : Any type, any ratings

Cleaning conditions: Total cleaning time shall be within 2 minutes by immersion, ultrasonic or other methods.

Temperature of the cleaning agents shall be 40°C or below. After cleaning, capacitors should be dried by using hot air for the minimum 10 minutes along with the PC board mounted. Hot air temperature should be within the maximum operating temperature of the capacitor. Insufficient dryness after water rinse may cause appearance problems, such as bottom-plate bulge and etc.;

Avoid using ozone destructive substances as cleaning agents for protecting global environment.

#### IN THE EQUIPMENT

1) Do not directly touch terminal by hand.

2) Do not link positive terminal and negative terminal by conductor, nor spill conductible liquid such as alkaline or acidic solution on or near the capacitor.

3) Please make sure that the ambient conditions where the set is installed are free from spilling water or oil, direct sunlight, ultraviolet rays, radiation, poisonous gases, vibration or mechanical shock.

#### MAINTENANCE AND INSPECTION

Please periodically inspect the aluminum capacitors that are installed in industrial equipment. The following items should be checked:

Appearance: remarkable abnormality such as pressure relief vent opening, electrolyte leaking, etc.

Electrical characteristics: capacitance, dielectric loss tangent, leakage current and etc., which are specified in catalogue or alternate product specification.

#### IN AN EMERGENCY

1) If you see smoke due to operation of safety vent, please turn off the main switch or pull out the plug from the outlet.

2) If you breathe the gas or ingest the electrolyte, please wash out your mouth and throat with water immediately.

3) If your skin is exposed to the electrolyte, please wash it away using soap and water.

#### STORAGE

1) Do not keep capacitor in high temperature and high humidity atmosphere. Storage conditions should be:

Temperature: 5°C~ 35°C Humidity : lower than 75% Place : Indoor

2) Avoid ambient conditions where capacitors are covered with water, brine or oil.

3) A storage products for longer than 12 months is not recommended. Within other effects, the terminals may suffer degradation, resulting in bad solderability. All products shall be used within the period of 12 months based on the day of shipment

#### DISPOSAL

Please take either of the following methods in disposing capacitors.

1) Incinerate them after crushing capacitors or making a hole on the capacitor body.

2) If incineration is not applicable, hand them over to a waste disposal agent and have them buried in landfills.

## IMPORTANT NOTES AND DISCLAIMER

1. **ROHS COMPLIANCE:** The levels of RoHS restricted materials in this product are below the maximum concentration values (also referred to as the threshold limits) permitted for such substances, or are used in an exempted application, in accordance with EU RoHS Directive (EU) 2015/863 EC (RoHS3). RoHS Test Report for this product can be obtained at Download Center.
2. **REACH COMPLIANCE:** REACH substances of high concern (SVHCs) information is available for this product. Since the European Chemical Agency (ECHA) has published notice of their intent to frequently revise the SVHC listing for the foreseeable future, REACH Test Report for this product can be obtained at Download Center.
3. All Product parametric performance is indicated in the Electrical Characteristics for the listed herein test conditions, unless otherwise noted. Product performance may not be indicated by the Electrical Characteristics if operated under different conditions.
4. NextGen Component, Inc (*NextGen*) reserves the right to make changes to this document and its products and specifications at any time without notice. Customers should obtain and confirm the latest product information and specifications before final design, purchase or use.
5. *NextGen* makes no warranty, representation or guarantee regarding the suitability of its products for any particular purpose, not does *NextGen* assume any liability for application assistance or customer product design.
6. *NextGen* does not warrant or accept any liability with products which are purchased or used for any unintended or unauthorized application. No license is granted by implication or otherwise under any intellectual property rights of NextGen.
7. *NextGen* products are not authorized for use as critical components in life support devices or systems without express written approval by *NextGen*.
8. *NextGen* requires that customers first obtain an RMA (Returned Merchandise Authorization) number prior to returning any products. Returns must be made within 30 days of the date of invoice, be in the original packaging, unused and like-new condition. At the time of quoting or purchasing, a product may say that it is Non-Cancelable/ Non-Returnable (NCNR). These products are not returnable and not refundable.