



SPECIFICATION SHEET NO.	T0226- FZ337M025HFKTA		
ORIGINAL MFR. PART NO.	<b>Aillen</b> Aillen Capacitors/CAE337M1EHFZFJ5TR		
NEXTGEN ORDER PART NO.	FZ337M025HFKTA	This number is required on all RFQs and Purchase Orders	
DATE	Feb. 26, 2026		
REVISION	Rev. A6	Updated to reflect the most recent data	
GENERAL DESCRIPTION AND KEY SPECIFICATIONS	<p>Aluminum Electrolytic Capacitors (CAE), SMD Type – FZ Series, 2 Pads Wide operating temperature range and low impedance</p> <p>Capacitance: 330 <math>\mu</math>F; Capacitance Tolerance: <math>\pm</math>20%; Rated Voltage: 25 V Case Size: <math>\varnothing</math>8.00 <math>\times</math> 10.5 mm; Impedance (20 <math>^{\circ}</math>C, 100 kHz): 0.17 <math>\Omega</math> (Max.) Ripple Current (r.m.s., 100 kHz, +105 <math>^{\circ}</math>C): 450 mA (Max.) Load Life: 5000 hours at +105 <math>^{\circ}</math>C Operating Temperature Range: -55 <math>^{\circ}</math>C to +105 <math>^{\circ}</math>C Packing: Tape and Reel, 500 pcs/reel Compliance: REACH and RoHS (2011/65/EU &amp; 2015/863/EU) compliant; Halogen-Free (HF)</p>		
CUSTOMER			
CUSTOMER PART NO.			
CROSS-REFERENCE INFORMATION	UFW/UWT/UWX,VX/EX/KYB, ZLH/ZS  Functional Alternative (Subject to Application Verification)		

<b>VENDOR APPROVAL</b>			
Prepared by	Checked by	Approved by	
			
Date: Feb. 26, 2026			

<b>CUSTOMER APPROVAL</b>			
Signature:	Name:	Title:	Date:

## MAIN FEATURES

- Aluminum electrolytic capacitors, foil type
- V-Chip (Radial SMD) can-type construction
- Wide operating temperature range:  $-55\text{ }^{\circ}\text{C}$  to  $+105\text{ }^{\circ}\text{C}$
- High reliability and stable electrical characteristics
- Designed to meet IEC 60384 requirements
- Suitable for high-density surface mount applications
- Rated voltage range: up to 100 V
- Capacitance range: up to 2200  $\mu\text{F}$
- This product may serve as a functional alternative to comparable series such as Nichicon UFW, Chemi-Con VX/EX, and Rubycon ZS, subject to customer verification.
- Moisture Sensitivity Level (MSL): Level 1 (Unlimited)
- RoHS compliant per Directive 2011/65/EU and amendment (EU) 2015/863
- REACH compliant and Halogen-Free (HF)



*Image shown is a representation only. Exact specifications should be obtained from the product dimension.*



## APPLICATIONS

- High-density surface mount circuits, such as power supplies and lighting equipment
- Industrial equipment, including routers, network switches, measuring instruments, and control systems
- Consumer electronics, including audio amplifiers, smoothing circuits, and LED lighting

## ELECTRICAL CHARACTERISTICS

- Electrical characteristics for individual part numbers are provided on Pages 8–18.

## IMPORTANT NOTICE

- Specifications are subject to change without prior notice due to product improvements or technical updates.
- Customers are responsible for verifying the latest product information prior to use.
- All product parameters are subject to final confirmation by NextGen Components.

## HOW TO ORDER

- Please refer to the part numbering structure and specify the NextGen order part number FZ337M025HFKTA on all RFQs and Purchase Orders.

**RFQ**  
[Request For Quotation](#)

## PART NUMBERING STRUCTURE

CODE	DESCRIPTION	KEY SPECIFICATIONS
FZ	Series	Aluminum Electrolytic Capacitors(CAE), V-Chip Type, Original MFR Series Number CDFZ
337	Capacitance	225: 2.2μF; 335: 3.3μF; 475: 4.7μF; 105: 1.0μF; 106: 10μF; 156: 15μF; 226: 22μF; 276: 27μF; 336: 33μF; 476: 47μF; 566: 56μF; 686: 68μF; 107: 100μF; 157: 150μF; 227: 220μF 337: 330μF; 477: 470μF; 687: 680μF; 108: 1000μF; 158: 1500μF; 228: 2200μF
M	Capacitance Tolerance	M: ±20% (Standard)
025	Rated Voltage	6V3: 6.3 V; 010: 10 V; 016: 16 V; 025: 25 V; 035: 35 V; 050: 50 V; 063: 63 V; 080: 80 V; 100: 100 V
H	Environmental Compliance	H: REACH and RoHS compliant per Directive 2011/65/EU and amendment (EU) 2015/863; Halogen-Free (HF)
F	Case Diameter	C: Ø4.0mm; D: Ø5.0mm; E: Ø6.3mm; F: Ø8.0mm; G: Ø10.0mm P: Ø12.5mm
K	Case Length	H: 5.7 mm; I: 6.5 mm; J: 7.7 mm; K: 10.5 mm; N: 13.5 mm
T	Packaging	T: Tape and Reel
A	Internal Control Code	Letter A~Z, a~z or digits (0~9)
XX	Suffix	Blank: Standard; XX: Letters A~Z, a~z or digits (0~9) for Custom or special specification (if applicable)

**DIMENSIONS (Unit: mm)**

- $\varnothing 4.0$  mm to  $\varnothing 6.3$  mm: Without safety vent.
- $\varnothing 8.0$  mm to  $\varnothing 12.5$  mm: With safety vent

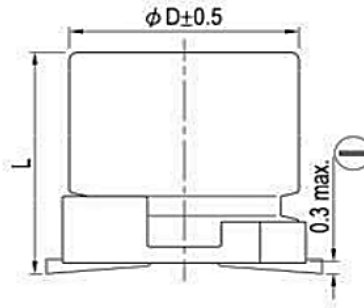
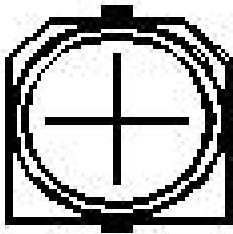

K

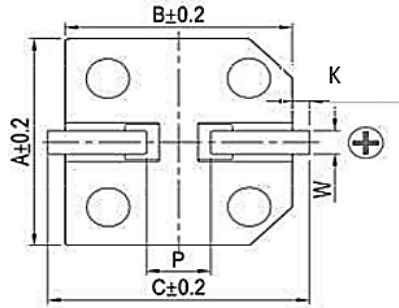

$\varnothing D$	4.0	5.0	6.3	6.3	8.0	8.0	10.0	10.0	12.5
Case L	5.7 $\pm$ 0.5	5.7 $\pm$ 0.5	5.7 $\pm$ 0.5	7.7 $\pm$ 0.5	6.5 $\pm$ 0.5	10.5 $\pm$ 0.5	10.5 $\pm$ 0.5	13.5 $\pm$ 0.5	13.5 $\pm$ 0.5
A	4.3	5.3	6.6	6.6	8.3	8.3	10.3	10.3	13.0
B	4.3	5.3	6.6	6.6	8.3	8.3	10.3	10.3	13.0
C	5.1	6.1	7.3	7.3	9.2	9.2	11.2	11.2	13.7
P	1.0 $\pm$ 0.2	1.5 $\pm$ 0.2	2.1 $\pm$ 0.2	2.1 $\pm$ 0.2	3.1 $\pm$ 0.2	3.1 $\pm$ 0.2	4.5 $\pm$ 0.2	4.5 $\pm$ 0.2	4.5 $\pm$ 0.2
K	0.5 Max.	0.5 Max.	0.5 Max.	0.5 Max.	0.5 Max.	0.5 Max.	0.5 Max.	0.5 Max.	1.0 Max.
W	0.5~0.9	0.5~0.9	0.5~0.9	0.5~0.9	0.8~1.1	0.8~1.1	0.8~1.1	0.8~1.1	1.1~1.4

MARKING GUIDE – For Reference Only

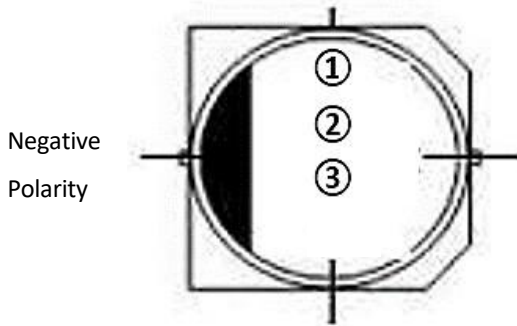

SYMBOL	NAME	VALUE	MARKING
①	Series Code		FZ
②	Rated Capacitance	330 $\mu$ F	330
③	Rated Voltage	25V	25V

RECOMMENDED LAND PATTERN (Unit: mm)

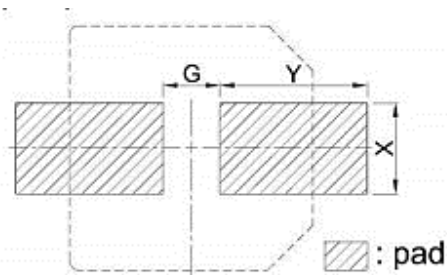

DIAMETER SIZE	X	Y	G
$\varnothing 4$	1.6	2.6	1.0
$\varnothing 5$	1.6	3.0	1.4
$\varnothing 6.3$	1.6	3.5	1.9
$\varnothing 8$	2.5	3.5	3.0
$\varnothing 10$	2.5	4.0	4.0
$\varnothing 12.5$	3.2	6.0	4.0

CONSTRUCTION – For Reference Only

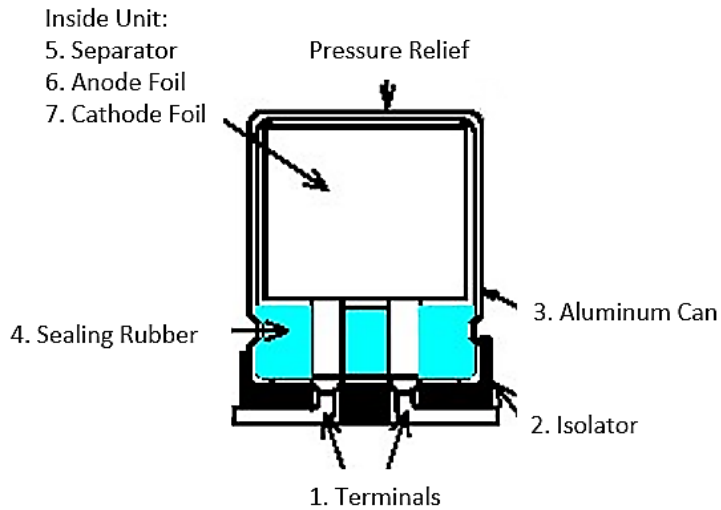

NO.	PARTS	MATERIAL
1	Terminal	Tinned Copper – Clad Steel Wire (Pb Free)
2	Isolator	Thermo-plastic resin
3	Aluminum Can	Aluminum
4	Sealing Rubber	Synthetic rubber
5	Separator	Manila hemp
6	Anode Foil	High purity aluminum foil
7	Cathode Foil	Aluminum foil

**GENERAL ELECTRICAL CHARACTERISTICS – FOR DIFFERENT NEXTGEN ORDER PART NO.**

PARAMETER	UNITS	VALUE
Operating Junction Temperature Range	°C	-55 ~ +105
Storage Temperature Range	°C	-55 ~ +150

**FREQUENCY COEFFICIENT OF ALLOWABLE RIPPLE CURRENT**

FREQUENCY F(Hz)		100Hz≤F < 1KHz	1KHz≤F < 10KHz	10KHz≤F < 100KHz	100KHz≤F
Capacitance C(μF)	C≤33	0.35	0.70	0.90	1.00
	33 < C≤150	0.45	0.85	0.92	1.00
	150 < C	0.60	0.85	0.95	1.00

**TEMPERATURE COEFFICIENT**

AMBIENT TEMPERATURE (°C)	105	85	≤70
Coefficient	1	1.5	2

ELECTRICAL CHARACTERISTICS - Ta = 25°C, FOR DIFFERENT NEXTGEN ORDER PART NO.

NEXTGEN ORDER PART NO.	RATE VOL.	CAPACI- TANCE	MAX. DF @20°C, 120HZ	MAX. LEAKAGE CURRENT	MAX. IMPEDANCE @ 20 °C 100KHZ	MAX. RIPPLE CURRENT @ 105°C 100KHZ	LOAD LIFE	CASE SIZE ØD X L
	V	µF	%	µA	Ω	mA r.m.s	Hours	mm
FZ226M6V3HCHTA	6.3	22	26	3.00	1.45	80	2000	4x5.7
FZ276M6V3HCHTA	6.3	27	26	3.00	1.45	80	2000	4x5.7
FZ336M6V3HDHTA	6.3	33	26	3.00	0.80	150	2000	5x5.7
FZ476M6V3HDHTA	6.3	47	26	3.00	0.80	150	2000	5x5.7
FZ566M6V3HDHTA	6.3	56	26	3.53	0.80	150	2000	5x5.7
FZ686M6V3HEHTA	6.3	68	26	4.28	0.44	230	2000	6.3x5.7
FZ107M6V3HDHTA	6.3	100	26	6.30	0.80	150	2000	5x5.7
FZ107M6V3HEHTA	6.3	100	26	6.30	0.44	230	2000	6.3x5.7
FZ157M6V3HEHTA	6.3	150	26	9.45	0.44	230	2000	6.3x5.7
FZ227M6V3HEHTA	6.3	220	26	13.86	0.44	230	2000	6.3x5.7
FZ337M6V3HEJTA	6.3	330	26	20.79	0.36	280	3000	6.3x7.7
FZ337M6V3HFITA	6.3	330	26	20.79	0.36	280	3000	8x6.5
FZ477M6V3HFKTA	6.3	470	26	29.61	0.17	450	5000	8x10.5
FZ477M6V3HFKTB	6.3	470	26	29.61	0.16	600	5000	8x10.5
FZ687M6V3HFKTA	6.3	680	26	42.84	0.17	450	5000	8x10.5
FZ687M6V3HGJTA	6.3	680	26	42.84	0.17	450	3000	10x7.7
FZ108M6V3HFKTA	6.3	1000	28	63.00	0.17	450	5000	8x10.5
FZ158M6V3HGKTA	6.3	1500	28	94.50	0.09	670	5000	10x10.5
FZ158M6V3HGNTA	6.3	1500	28	94.50	0.08	720	5000	10x13.5
FZ228M6V3HPNTA	6.3	2200	29	138.60	0.07	820	5000	12.5x13.5



ELECTRICAL CHARACTERISTICS - Ta = 25°C, FOR DIFFERENT NEXTGEN ORDER PART NO.

NEXTGEN ORDER PART NO.	RATE VOL.	CAPACI- TANCE	MAX. DF @20°C, 120HZ	MAX. LEAKAGE CURRENT	MAX. IMPEDANCE @ 20 °C 100KHZ	MAX. RIPPLE CURRENT @ 105°C 100KHZ	LOAD LIFE	CASE SIZE ØD X L
	V	µF	%	µA	Ω	mA r.m.s	Hours	mm
FZ226M010HCHTA	10	22	22	3.00	1.45	80	2000	4x5.7
FZ276M010HDHTA	10	27	22	3.00	0.80	150	2000	5x5.7
FZ336M010HDHTA	10	33	22	3.30	0.80	150	2000	5x5.7
FZ476M010HEHTA	10	47	22	4.70	0.44	230	2000	6.3x5.7
FZ566M010HEHTA	10	56	22	5.60	0.44	230	2000	6.3x5.7
FZ686M010HEHTA	10	68	22	6.80	0.44	230	2000	6.3x5.7
FZ107M010HEHTA	10	100	22	10.00	0.44	230	2000	6.3x5.7
FZ157M010HEHTA	10	150	22	15.00	0.44	230	2000	6.3x5.7
FZ227M010HEJTA	10	220	22	22.00	0.36	280	3000	6.3x7.7
FZ227M010HFITA	10	220	22	22.00	0.36	280	3000	8x6.5
FZ337M010HFKTA	10	330	22	33.00	0.17	450	5000	8x10.5
FZ477M010HFKTA	10	470	22	47.00	0.17	450	5000	8x10.5
FZ477M010HGJTA	10	470	22	47.00	0.17	450	3000	10x7.7
FZ687M010HGKTA	10	680	22	68.00	0.09	850	5000	10x10.5
FZ108M010HGKTA	10	1000	24	100.00	0.09	850	5000	10x10.5
FZ108M010HGKTB	10	1000	24	100.00	0.08	850	5000	10x10.5
FZ158M010HGNTA	10	1500	27	150.00	0.08	720	5000	10x13.5
FZ158M010HPNTA	10	1500	27	150.00	0.07	820	5000	12.5x13.5
FZ228M010HPNTA	10	2200	29	220.00	0.07	820	5000	12.5x13.5

ELECTRICAL CHARACTERISTICS - Ta = 25°C, FOR DIFFERENT NEXTGEN ORDER PART NO.

NEXTGEN ORDER PART NO.	RATE VOL.	CAPACITANCE	MAX. DF @20°C, 120HZ	MAX. LEAKAGE CURRENT	MAX. IMPEDANCE @ 20 °C 100KHZ	MAX. RIPPLE CURRENT @ 105°C 100KHZ	LOAD LIFE	CASE SIZE ØD X L
	V	µF	%	µA	Ω	mA r.m.s	Hours	mm
FZ106M016HCHTA	16	10	20	3.00	1.45	80	2000	4x5.7
FZ226M016HDHTA	16	22	20	3.52	0.80	150	2000	5x5.7
FZ276M016HDHTA	16	27	20	4.32	0.80	150	2000	5x5.7
FZ336M016HEHTA	16	33	20	5.28	0.44	230	2000	6.3x5.7
FZ476M016HEHTA	16	47	20	7.52	0.44	230	2000	6.3x5.7
FZ566M016HEHTA	16	56	20	8.96	0.44	230	2000	6.3x5.7
FZ686M016HEHTA	16	68	20	10.88	0.44	230	2000	6.3x5.7
FZ107M016HEHTA	16	100	20	16.00	0.44	230	2000	6.3x5.7
FZ157M016HEJTA	16	150	20	24.00	0.36	280	3000	6.3x7.7
FZ157M016HFITA	16	150	20	24.00	0.36	280	3000	8x6.5
FZ227M016HEJTA	16	220	20	35.20	0.36	280	3000	6.3x7.7
FZ337M016HFKTA	16	330	20	52.80	0.17	450	5000	8x10.5
FZ337M016HGJTA	16	330	20	52.80	0.17	450	3000	10x7.7
FZ477M016HFKTA	16	470	20	75.20	0.17	450	5000	8x10.5
FZ687M016HGKTA	16	680	20	108.80	0.09	850	5000	10x10.5
FZ108M016HGNTA	16	1000	22	160.00	0.08	720	5000	10x13.5
FZ108M016HPNTA	16	1000	22	160.00	0.07	820	5000	12.5x13.5
FZ158M016HPNTA	16	1500	22	240.00	0.07	820	5000	12.5x13.5

ELECTRICAL CHARACTERISTICS - Ta = 25°C, FOR DIFFERENT NEXTGEN ORDER PART NO.

NEXTGEN ORDER PART NO.	RATE VOL.	CAPACI- TANCE	MAX. DF @20°C, 120HZ	MAX. LEAKAGE CURRENT	MAX. IMPEDANCE @ 20 °C 100KHZ	MAX. RIPPLE CURRENT @ 105°C 100KHZ	LOAD LIFE	CASE SIZE ØD X L
	V	µF	%	µA	Ω	mA r.m.s	Hours	mm
FZ106M025HCHTA	25	10	18	3.00	1.45	80	2000	4x5.7
FZ156M025HDHTA	25	15	18	3.75	0.80	150	2000	5x5.7
FZ226M025HDHTA	25	22	18	5.50	0.80	150	2000	5x5.7
FZ276M025HEHTA	25	27	18	6.75	0.44	230	2000	6.3x5.7
FZ336M025HEHTA	25	33	18	8.25	0.44	230	2000	6.3x5.7
FZ476M025HEHTA	25	47	18	11.75	0.44	230	2000	6.3x5.7
FZ566M025HEHTA	25	56	18	14.00	0.44	230	2000	6.3x5.7
FZ686M025HEHTA	25	68	18	17.00	0.44	230	2000	6.3x5.7
FZ107M025HEJTA	25	100	18	25.00	0.36	280	3000	6.3x7.7
FZ107M025HFITA	25	100	18	25.00	0.36	280	3000	8x6.5
FZ157M025HFKTA	25	150	18	37.50	0.17	450	5000	8x10.5
FZ227M025HFKTA	25	220	18	55.00	0.17	450	5000	8x10.5
FZ227M025HGJTA	25	220	18	55.00	0.17	450	3000	10x7.7
<b>FZ337M025HFKTA</b>	25	330	18	82.50	0.17	450	5000	8x10.5
FZ337M025HFKTB	25	330	18	82.50	0.16	600	5000	8x10.5
FZ337M025HGKTA	25	330	18	82.50	0.09	670	5000	10x10.5
FZ477M025HGKTA	25	470	18	117.50	0.09	670	5000	10x10.5
FZ477M025HGKTB	25	470	18	117.50	0.09	850	5000	10x10.5
FZ687M025HGNTA	25	680	18	170.00	0.08	720	5000	10x13.5
FZ687M025HPNTA	25	680	18	170.00	0.07	820	5000	12.5x13.5

ELECTRICAL CHARACTERISTICS -  $T_a = 25^{\circ}\text{C}$ , FOR DIFFERENT NEXTGEN ORDER PART NO.

NEXTGEN ORDER PART NO.	RATE VOL.	CAPACI- TANCE	MAX. DF @20°C, 120HZ	MAX. LEAKAGE CURRENT	MAX. IMPEDANCE @20 °C 100KHZ	MAX. RIPPLE CURRENT @ 105°C 100KHZ	LOAD LIFE	CASE SIZE ØD X L
	V	µF	%	µA	Ω	mA r.m.s	Hours	mm
FZ108M025HPNTA	25	1000	20	250.00	0.07	820	5000	12.5x13.5
FZ108M025HPNTB	25	1000	20	250.00	0.06	1100	5000	12.5x13.5

ELECTRICAL CHARACTERISTICS - Ta = 25°C, FOR DIFFERENT NEXTGEN ORDER PART NO.

NEXTGEN ORDER PART NO.	RATE VOL.	CAPACI- TANCE	MAX. DF @20°C, 120HZ	MAX. LEAKAGE CURRENT	MAX. IMPEDANCE @ 20 °C 100KHZ	MAX. RIPPLE CURRENT @ 105°C 100KHZ	LOAD LIFE	CASE SIZE ØD X L
	V	µF	%	µA	Ω	mA r.m.s	Hours	mm
FZ475M035HCHTA	35	4.7	14	3.00	1.45	80	2000	4x5.7
FZ106M035HDHTA	35	10	14	3.50	0.80	150	2000	5x5.7
FZ156M035HDHTA	35	15	14	5.25	0.80	150	2000	5x5.7
FZ226M035HDHTA	35	22	14	7.70	0.80	150	2000	5x5.7
FZ226M035HEHTA	35	22	14	7.70	0.80	150	2000	6.3x5.7
FZ226M035HEHTB	35	22	14	7.70	0.44	230	2000	6.3x5.7
FZ276M035HEHTA	35	27	14	9.45	0.44	230	2000	6.3x5.7
FZ336M035HEHTA	35	33	14	11.55	0.44	230	2000	6.3x5.7
FZ476M035HEHTA	35	47	14	16.45	0.44	230	2000	6.3x5.7
FZ476M035HFITA	35	47	14	16.45	0.44	230	3000	8x6.5
FZ566M035HEJTA	35	56	14	19.60	0.36	280	3000	6.3x7.7
FZ686M035HEJTA	35	68	14	23.80	0.36	280	3000	6.3x7.7
FZ107M035HEJTA	35	100	14	35.00	0.36	280	3000	6.3x7.7
FZ107M035HFKTA	35	100	14	35.00	0.17	450	5000	8x10.5
FZ157M035HFKTA	35	150	14	52.50	0.17	450	5000	8x10.5
FZ157M035HGJTA	35	150	14	52.50	0.17	450	3000	10x7.7
FZ227M035HFKTA	35	220	14	77.00	0.17	600	5000	8x10.5
FZ227M035HGKTA	35	220	14	77.00	0.09	670	5000	10x10.5
FZ337M035HGKTA	35	330	16	115.50	0.09	670	5000	10x10.5
FZ477M035HGNTA	35	470	18	164.50	0.08	720	5000	10x13.5

ELECTRICAL CHARACTERISTICS - Ta = 25°C, FOR DIFFERENT NEXTGEN ORDER PART NO.

NEXTGEN ORDER PART NO.	RATE VOL.	CAPACI- TANCE	MAX. DF @20°C, 120HZ	MAX. LEAKAGE CURRENT	MAX. IMPEDANCE @20 °C 100KHZ	MAX. RIPPLE CURRENT @ 105°C 100KHZ	LOAD LIFE	CASE SIZE ØD X L
	V	µF	%	µA	Ω	mA r.m.s	Hours	mm
FZ477M035HPNTA	35	470	18	164.50	0.07	820	5000	12.5x13.5
FZ687M035HPNTA	35	680	18	238.00	0.07	820	5000	12.5x13.5

**ELECTRICAL CHARACTERISTICS - Ta = 25°C, FOR DIFFERENT NEXTGEN ORDER PART NO.**

NEXTGEN ORDER PART NO.	RATE VOL.	CAPACI- TANCE	MAX. DF @20°C, 120HZ	MAX. LEAKAGE CURRENT	MAX. IMPEDANCE @ 20 °C 100KHZ	MAX. RIPPLE CURRENT @ 105°C 100KHZ	LOAD LIFE	CASE SIZE ØD X L
	V	µF	%	µA	Ω	mA r.m.s	Hours	mm
FZ105M050HCHTA	50	1	12	3.00	2.90	60	2000	4x5.7
FZ475M050HCHTA	50	4.7	12	3.00	2.90	60	2000	4x5.7
FZ106M050HDHTB	50	10	12	5.00	1.52	85	2000	5x5.7
FZ106M050HEHTA	50	10	12	5.00	0.88	165	2000	6.3x5.7
FZ226M050HEHTA	50	22	12	11.00	0.88	165	2000	6.3x5.7
FZ276M050HEJTA	50	27	12	13.50	0.68	185	3000	6.3x7.7
FZ336M050HEJTA	50	33	12	16.50	0.68	185	3000	6.3x7.7
FZ476M050HEJTA	50	47	12	23.50	0.68	185	3000	6.3x7.7
FZ476M050HEJTB	50	47	12	23.50	0.68	195	3000	6.3x7.7
FZ476M050HFITA	50	47	12	23.50	0.68	185	3000	8x6.5
FZ476M050HFITB	50	47	12	23.50	0.68	195	3000	8x6.5
FZ566M050HFKTA	50	56	12	28.00	0.34	360	5000	8x10.5
FZ686M050HFKTA	50	68	12	34.00	0.34	360	5000	8x10.5
FZ107M050HFKTA	50	100	12	50.00	0.34	360	5000	8x10.5
FZ107M050HGJTA	50	100	12	50.00	0.34	330	3000	10x7.7
FZ157M050HGKTA	50	150	12	75.00	0.18	670	5000	10x10.5
FZ227M050HGKTA	50	220	12	110.00	0.18	670	5000	10x10.5
FZ337M050HPNTA	50	330	12	165.00	0.12	900	5000	12.5x13.5

ELECTRICAL CHARACTERISTICS - Ta = 25°C, FOR DIFFERENT NEXTGEN ORDER PART NO.

NEXTGEN ORDER PART NO.	RATE VOL.	CAPACITANCE	MAX. DF @20°C, 120HZ	MAX. LEAKAGE CURRENT	MAX. IMPEDANCE @ 20 °C 100KHZ	MAX. RIPPLE CURRENT @ 105°C 100KHZ	LOAD LIFE	CASE SIZE ØD X L
	V	µF	%	µA	Ω	mA r.m.s	Hours	mm
FZ475M063HDHTA	63	4.7	12	3.00	2.90	60	2000	5x5.7
FZ106M063HEHTA	63	10	12	6.30	1.50	80	2000	6.3x5.7
FZ226M063HEJTA	63	22	12	13.86	1.20	120	3000	6.3x7.7
FZ336M063HFITA	63	33	12	20.79	1.20	120	3000	8x6.5
FZ336M063HFKTA	63	33	12	20.79	0.65	250	5000	8x10.5
FZ476M063HFKTA	63	47	12	29.61	0.65	250	5000	8x10.5
FZ566M063HFKTA	63	56	12	35.28	0.65	250	5000	8x10.5
FZ686M063HFKTA	63	68	12	42.84	0.65	250	5000	8x10.5
FZ107M063HGKTA	63	100	12	63.00	0.35	400	5000	10x10.5
FZ107M063HPNTA	63	100	14	63.00	0.16	800	5000	12.5x13.5
FZ157M063HPNTA	63	150	14	94.50	0.16	800	5000	12.5x13.5
FZ227M063HPNTA	63	220	14	138.60	0.16	800	5000	12.5x13.5



ELECTRICAL CHARACTERISTICS - Ta = 25°C, FOR DIFFERENT NEXTGEN ORDER PART NO.

NEXTGEN ORDER PART NO.	RATE VOL.	CAPACI- TANCE	MAX. DF @20°C, 120HZ	MAX. LEAKAGE CURRENT	MAX. IMPEDANCE @ 20 °C 100KHZ	MAX. RIPPLE CURRENT @ 105°C 100KHZ	LOAD LIFE	CASE SIZE ØD X L
	V	µF	%	µA	Ω	mA r.m.s	Hours	mm
FZ475M080HEHTA	80	4.7	12	3.76	3.00	40	2000	6.3x5.7
FZ106M080HEJTA	80	10	12	8.00	2.40	60	3000	6.3x7.7
FZ226M080HFKTA	80	22	12	17.60	1.30	130	5000	8x10.5
FZ276M080HGKTA	80	27	12	21.60	0.70	200	5000	10x10.5
FZ336M080HFKTA	80	33	12	26.40	1.30	130	5000	8x10.5
FZ476M080HGKTA	80	47	12	37.60	0.70	200	5000	10x10.5
FZ686M080HGNTA	80	68	14	54.40	0.45	300	5000	10x13.5
FZ107M080HGNTA	80	100	14	80.00	0.45	300	5000	10x13.5
FZ107M080HPNTA	80	100	14	80.00	0.32	500	5000	12.5x13.5
FZ157M080HPNTA	80	150	14	120.00	0.32	500	5000	12.5x13.5

**ELECTRICAL CHARACTERISTICS - Ta = 25°C, FOR DIFFERENT NEXTGEN ORDER PART NO.**

NEXTGEN ORDER PART NO.	RATE VOL.	CAPACITANCE	MAX. DF @20°C, 120HZ	MAX. LEAKAGE CURRENT	MAX. IMPEDANCE @ 20 °C 100KHZ	MAX. RIPPLE CURRENT @ 105°C 100KHZ	LOAD LIFE	CASE SIZE ØD X L
	V	µF	%	µA	Ω	mA r.m.s	Hours	mm
FZ226M100HFKTA	100	22	12	22.00	1.30	130	5000	8x10.5
FZ336M100HGKTA	100	33	12	33.00	0.70	200	5000	10x10.5
FZ476M100HPNTA	100	47	14	47.00	0.32	500	5000	12.5x13.5
FZ686M100HPNTA	100	68	14	68.00	0.32	500	5000	12.5x13.5
FZ107M100HPNTA	100	100	14	100.00	0.32	500	5000	12.5x13.5

## CHARACTERISTICS

### Standard Atmospheric Conditions

The standard range of atmospheric conditions for making measurements/test as follows:

- Ambient temperature: 15 °C to 35 °C
- Relative humidity: 45% to 85%
- Air Pressure: 86kPa to 106kPa
- If there is any doubt about the results, measurement shall be made within the following conditions:
- Ambient temperature: 20 °C  $\pm$  2 °C
- Relative humidity: 60% to 70%
- Air Pressure: 86kPa to 106kPa
- As to the detailed information, please refer to following Table

### Operating Temperature Range

The ambient temperature range at which the capacitor can be operated continuously at rated voltage is  
-55 °C to 105 °C.

As to the detailed information, please refer to the mentioned table next pages.

ITEM	PERFORMANCE																																													
Nominal Capacitance (Tolerance)	<p>&lt;Condition&gt;</p> <p>Measuring Frequency : 120Hz ± 12Hz</p> <p>Measuring Voltage : Not more than 0.5V</p> <p>Measuring Temperature : 20 ± 2°C</p> <p>&lt;Criteria&gt;</p> <p>Shall be within the specified capacitance tolerance</p>																																													
Leakage Current	<p>&lt;Condition&gt;</p> <p>After DC Voltage is applied to capacitors through the series protective resistor (1kΩ ± 10Ω) so that terminal voltage may reach the reacted use voltage. The leakage current when measured in 2 minutes shall not exceed the values of the following equation.</p> <p>&lt;Criteria&gt;</p> <p><math>I (\mu A) \leq 0.01 CV</math> or <math>3 (\mu A)</math>, Whichever is greater</p> <p>I: Leakage Current (μA)</p> <p>C: Capacitance (μF)</p> <p>V: Rated Working Voltage (V)</p>																																													
tan δ	<p>&lt;Condition&gt;</p> <p>See Normal Capacitance, for measuring frequency, voltage and temperature.</p> <p>&lt;Criteria&gt;</p> <p>The tangent of the loss angle (tan δ) of the capacitors shall refer to the following table. Measurements shall be made under the same conditions as those given for the measurement of the capacitance.</p> <table border="1" style="margin: 10px auto; border-collapse: collapse; text-align: center;"> <thead> <tr> <th>W.V.</th> <th>Cap.(μF)</th> <th>6.3</th> <th>10</th> <th>16</th> <th>25</th> </tr> </thead> <tbody> <tr> <td rowspan="4">tan δ</td> <td>&lt;1000</td> <td>0.26</td> <td>0.22</td> <td>0.20</td> <td>0.18</td> </tr> <tr> <td>1000</td> <td>0.28</td> <td>0.24</td> <td>0.22</td> <td>0.20</td> </tr> <tr> <td>1500</td> <td>0.28</td> <td>0.27</td> <td>/</td> <td>/</td> </tr> <tr> <td>2200</td> <td>0.34</td> <td>0.29</td> <td>/</td> <td>/</td> </tr> </tbody> </table> <table border="1" style="margin: 10px auto; border-collapse: collapse; text-align: center;"> <thead> <tr> <th>W.V.</th> <th>Cap.(μF)</th> <th>35</th> <th>50</th> <th>100</th> </tr> </thead> <tbody> <tr> <td rowspan="3">tan δ</td> <td>&lt;330</td> <td>0.14</td> <td>0.12</td> <td>0.14</td> </tr> <tr> <td>330</td> <td>0.16</td> <td>0.12</td> <td>0.18</td> </tr> <tr> <td>470</td> <td>0.18</td> <td>0.14</td> <td>0.18</td> </tr> </tbody> </table> <p>Remark: Refer to this document for tan δ of other voltages.</p>	W.V.	Cap.(μF)	6.3	10	16	25	tan δ	<1000	0.26	0.22	0.20	0.18	1000	0.28	0.24	0.22	0.20	1500	0.28	0.27	/	/	2200	0.34	0.29	/	/	W.V.	Cap.(μF)	35	50	100	tan δ	<330	0.14	0.12	0.14	330	0.16	0.12	0.18	470	0.18	0.14	0.18
W.V.	Cap.(μF)	6.3	10	16	25																																									
tan δ	<1000	0.26	0.22	0.20	0.18																																									
	1000	0.28	0.24	0.22	0.20																																									
	1500	0.28	0.27	/	/																																									
	2200	0.34	0.29	/	/																																									
W.V.	Cap.(μF)	35	50	100																																										
tan δ	<330	0.14	0.12	0.14																																										
	330	0.16	0.12	0.18																																										
	470	0.18	0.14	0.18																																										

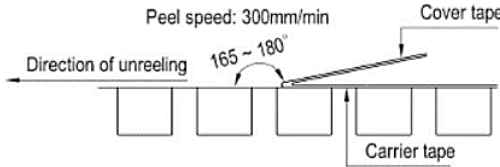
ITEM	PERFORMANCE																																													
Rated voltage (WV)  Surge voltage (SV)	<table border="1" style="width: 100%; border-collapse: collapse; text-align: center;"> <tr> <td style="width: 10%;">W.V. (V.DC)</td> <td>6.3</td> <td>10</td> <td>16</td> <td>25</td> <td>35</td> <td>50</td> <td>63</td> <td>80</td> <td>100</td> </tr> <tr> <td>S.V. (V.DC.)</td> <td>7.2</td> <td>11.5</td> <td>18.4</td> <td>28.8</td> <td>40.2</td> <td>57.5</td> <td>72.5</td> <td>92</td> <td>115</td> </tr> </table>	W.V. (V.DC)	6.3	10	16	25	35	50	63	80	100	S.V. (V.DC.)	7.2	11.5	18.4	28.8	40.2	57.5	72.5	92	115																									
W.V. (V.DC)	6.3	10	16	25	35	50	63	80	100																																					
S.V. (V.DC.)	7.2	11.5	18.4	28.8	40.2	57.5	72.5	92	115																																					
Temperature Characteristic IEC-60384-4 4.12	<p>&lt;Condition&gt;</p> <table border="1" style="width: 100%; border-collapse: collapse; text-align: center;"> <thead> <tr> <th>Step.</th> <th>Testing Temperature(°C)</th> <th>Time</th> </tr> </thead> <tbody> <tr> <td>1</td> <td>20 ± 2</td> <td>Time to reach thermal equilibrium</td> </tr> <tr> <td>2</td> <td>-55(-25) ± 3</td> <td>Time to reach thermal equilibrium</td> </tr> <tr> <td>3</td> <td>20 ± 2</td> <td>Time to reach thermal equilibrium</td> </tr> <tr> <td>4.</td> <td>105 ± 2</td> <td>Time to reach thermal equilibrium</td> </tr> <tr> <td>5</td> <td>20 ± 2</td> <td>Time to reach thermal equilibrium</td> </tr> </tbody> </table> <p>&lt;Criteria&gt;</p> <p>a) At +105°C, capacitance shall be within ±20% of their origin at +20°C, measured capacitance, tan δ shall be within limit of 4.3. The leakage current value at +105°C shall not more than 8 times the specified value.</p> <p>b) At step 5, tan δ shall be within the limit of 4.3. The leakage current value shall not more than the specified value.</p> <p>c) At -55°C (-25°C), impedance (Z) ratio shall not exceed the value of the following table.</p> <table border="1" style="width: 100%; border-collapse: collapse; text-align: center;"> <thead> <tr> <th>Rated Voltage (V)</th> <th>6.3</th> <th>10</th> <th>16</th> <th>25</th> <th>35</th> <th>50</th> <th>63/80</th> <th>100</th> </tr> </thead> <tbody> <tr> <td>Z-25°C/Z+20°C (120Hz)</td> <td>4</td> <td>3</td> <td>3</td> <td>2</td> <td>2</td> <td>2</td> <td>2</td> <td>2</td> </tr> <tr> <td>Z-55°C/Z+20°C (120Hz)</td> <td>8</td> <td>5</td> <td>4</td> <td>3</td> <td>3</td> <td>3</td> <td>3</td> <td>3</td> </tr> </tbody> </table> <p>d) Capacitance tan δ and impedance shall be measured at 120Hz</p>	Step.	Testing Temperature(°C)	Time	1	20 ± 2	Time to reach thermal equilibrium	2	-55(-25) ± 3	Time to reach thermal equilibrium	3	20 ± 2	Time to reach thermal equilibrium	4.	105 ± 2	Time to reach thermal equilibrium	5	20 ± 2	Time to reach thermal equilibrium	Rated Voltage (V)	6.3	10	16	25	35	50	63/80	100	Z-25°C/Z+20°C (120Hz)	4	3	3	2	2	2	2	2	Z-55°C/Z+20°C (120Hz)	8	5	4	3	3	3	3	3
Step.	Testing Temperature(°C)	Time																																												
1	20 ± 2	Time to reach thermal equilibrium																																												
2	-55(-25) ± 3	Time to reach thermal equilibrium																																												
3	20 ± 2	Time to reach thermal equilibrium																																												
4.	105 ± 2	Time to reach thermal equilibrium																																												
5	20 ± 2	Time to reach thermal equilibrium																																												
Rated Voltage (V)	6.3	10	16	25	35	50	63/80	100																																						
Z-25°C/Z+20°C (120Hz)	4	3	3	2	2	2	2	2																																						
Z-55°C/Z+20°C (120Hz)	8	5	4	3	3	3	3	3																																						
Sealing Tape Reel Strength	<p>&lt;Condition&gt;</p> <p>Peel angle: 165 to 180°C referred to the surface on which the tape is glued.</p> <p>Peel speed: 300mm per minutes</p> <p>The peel strength must be 0.1 ~ 0.7N under these conditions.</p> <div style="text-align: center;">  </div>																																													

ITEM	PERFORMANCE										
<p>Load Life Test IEC-60384- 4 4.13</p>	<p>&lt;Condition&gt; The capacitor is stored at a temperature of 105° C ±2 with rated voltage applied continuously for 2000Hrs for Ø D x L≤6.3x5.7mm;3000 Hrs for 6.3x7.7L &amp; 8x6.5L &amp; 10x7.7L;5000 Hrs for Ø D ≥ 8mm. Then the product should be tested after 16 hours recovering time at atmospheric conditions. The result should meet the following table:</p> <p>&lt;Criteria&gt; The characteristic shall meet the following requirements.</p> <table border="1" style="width: 100%; border-collapse: collapse; margin: 10px 0;"> <tr> <td style="width: 50%;">Capacitance Change</td> <td>± 30% of initial measured value.</td> </tr> <tr> <td>tan δ</td> <td>300% or less of the specified value</td> </tr> <tr> <td>Leakage current</td> <td>Not more than the specified value.</td> </tr> <tr> <td>Appearance</td> <td>No leakage of electrolyte or swelling of the case. All markings shall be legible</td> </tr> <tr> <td>Inner construction</td> <td>No corrosion of tab terminals or electrodes</td> </tr> </table> <p>Remarks: Prior to the measurement of the leakage current, the D.C. rated voltage shall be applied across the capacitor and its protective resistance (1kΩ) for 30 mines after which it shall be discharged.</p>	Capacitance Change	± 30% of initial measured value.	tan δ	300% or less of the specified value	Leakage current	Not more than the specified value.	Appearance	No leakage of electrolyte or swelling of the case. All markings shall be legible	Inner construction	No corrosion of tab terminals or electrodes
Capacitance Change	± 30% of initial measured value.										
tan δ	300% or less of the specified value										
Leakage current	Not more than the specified value.										
Appearance	No leakage of electrolyte or swelling of the case. All markings shall be legible										
Inner construction	No corrosion of tab terminals or electrodes										
<p>Shelf Life Test IEC-60384- 4 4.17</p>	<p>&lt;Condition&gt; The capacitors are then stored with no voltage applied at a temperature of 105 ±2°C for 1000+48/0 hours. Following this period the capacitors shall be removed from the test chamber and be allowed to stabilized at room temperature for 4~8 hours. Next they shall be connected to a series limiting resistor(1k±100Ω) with D.C. rated voltage applied for 30min. After which the capacitors shall be discharged, and then, tested the characteristics.</p> <p>&lt;Criteria&gt; The characteristic shall meet the following requirements.</p> <table border="1" style="width: 100%; border-collapse: collapse; margin: 10px 0;"> <tr> <td style="width: 50%;">Capacitance Change</td> <td>± 30% of initial measured value.</td> </tr> <tr> <td>tan δ</td> <td>300% or less of the specified value</td> </tr> <tr> <td>Leakage current</td> <td>Not more than 200% of the specified value</td> </tr> <tr> <td>Appearance</td> <td>No leakage of electrolyte or swelling of the case. All markings shall be legible</td> </tr> <tr> <td>Inner construction</td> <td>No corrosion of tab terminals or electrodes</td> </tr> </table> <p>Remark: If the capacitors are stored more than 1 year, the leakage current may increase. Please apply voltage through about 1 KΩ resistor, if necessary.</p>	Capacitance Change	± 30% of initial measured value.	tan δ	300% or less of the specified value	Leakage current	Not more than 200% of the specified value	Appearance	No leakage of electrolyte or swelling of the case. All markings shall be legible	Inner construction	No corrosion of tab terminals or electrodes
Capacitance Change	± 30% of initial measured value.										
tan δ	300% or less of the specified value										
Leakage current	Not more than 200% of the specified value										
Appearance	No leakage of electrolyte or swelling of the case. All markings shall be legible										
Inner construction	No corrosion of tab terminals or electrodes										

ITEM	PERFORMANCE								
<p>Surge Test IEC-60384- 4 4.9</p>	<p>&lt;Condition&gt; Test temperature:15~35°C Series resistor: <math>R = \frac{100 \pm 50}{C}</math> R: protective resistor (KΩ) C: nominal capacitance (μF) Test voltage: Surge voltage item 4.4 No. of cycles: 1000cycles Each cycles lasts for <math>6 \pm 0.5</math>min "ON" for <math>30 \pm 5</math> s "OFF" for <math>5 \pm 0.5</math>min.</p> <table border="1" data-bbox="404 665 1283 870"> <tr> <td>Leakage current</td> <td>Not more than the specified value</td> </tr> <tr> <td>Capacitance Change</td> <td>Within <math>\pm 15\%</math> of initial value.</td> </tr> <tr> <td>tan δ</td> <td>Not more than the specified value.</td> </tr> <tr> <td>Appearance</td> <td>There shall be no leakage of electrolyte.</td> </tr> </table> <p>Attention: This test simulates over voltage at abnormal situation and not be hypothesizing that over voltage is always applied.</p>	Leakage current	Not more than the specified value	Capacitance Change	Within $\pm 15\%$ of initial value.	tan δ	Not more than the specified value.	Appearance	There shall be no leakage of electrolyte.
Leakage current	Not more than the specified value								
Capacitance Change	Within $\pm 15\%$ of initial value.								
tan δ	Not more than the specified value.								
Appearance	There shall be no leakage of electrolyte.								
<p>Vibration Test IEC-60384- 4 4.8</p>	<p>&lt;Condition&gt; Fix it at the point 4 mm or less from body. For ones of 12.5 mm or more in diameter or 25 mm or Capacitance; Direction and during of vibration:3 orthogonal directions mutually each for 2 hours(total of 6 hours) Vibration frequency range : 10Hz ~ 55Hz Peak to peak amplitude : 1.5mm Sweep rate : 10Hz ~ 55Hz ~ 10Hz in about 1 minute &lt;Criteria&gt; The characteristic shall meet the following requirements.</p> <table border="1" data-bbox="404 1524 1283 1730"> <tr> <td>Leakage current</td> <td>Not more than the specified value</td> </tr> <tr> <td>Capacitance Change</td> <td>Within <math>\pm 10\%</math> of initial value.</td> </tr> <tr> <td>tan δ</td> <td>Not more than the specified value.</td> </tr> <tr> <td>Appearance</td> <td>There shall be no leakage of electrolyte.</td> </tr> </table>	Leakage current	Not more than the specified value	Capacitance Change	Within $\pm 10\%$ of initial value.	tan δ	Not more than the specified value.	Appearance	There shall be no leakage of electrolyte.
Leakage current	Not more than the specified value								
Capacitance Change	Within $\pm 10\%$ of initial value.								
tan δ	Not more than the specified value.								
Appearance	There shall be no leakage of electrolyte.								

ITEM	PERFORMANCE								
<p>Solderability Test IEC-60384-4 4.6</p>	<p>&lt;Condition&gt; The capacitor shall be tested under the following conditions: Soldering temperature: 245°C ± 3°C Dipping depth: 2mm Dipping speed: 25 ± 2.5mm/s Dipping time: 3 ± 0.5s &lt;Criteria&gt;</p> <table border="1" data-bbox="396 671 1253 754"> <tr> <td>Coating quality</td> <td>A minimum of 95% of the surface being immersed</td> </tr> </table>	Coating quality	A minimum of 95% of the surface being immersed						
Coating quality	A minimum of 95% of the surface being immersed								
<p>Resistance to solder heat test</p>	<p>&lt;Condition&gt; After reflow soldering The capacitor shall be left at room temperature for before measurement. &lt;Criteria&gt; The characteristic shall meet the following requirements.</p> <table border="1" data-bbox="396 1073 1253 1276"> <tr> <td>Leakage current</td> <td>Not more than the specified value</td> </tr> <tr> <td>Capacitance Change</td> <td>Within ± 10% of initial value.</td> </tr> <tr> <td>tan δ</td> <td>Not more than the specified value.</td> </tr> <tr> <td>Appearance</td> <td>There shall be no leakage of electrolyte.</td> </tr> </table>	Leakage current	Not more than the specified value	Capacitance Change	Within ± 10% of initial value.	tan δ	Not more than the specified value.	Appearance	There shall be no leakage of electrolyte.
Leakage current	Not more than the specified value								
Capacitance Change	Within ± 10% of initial value.								
tan δ	Not more than the specified value.								
Appearance	There shall be no leakage of electrolyte.								
<p>Damp heat test IEC60384-4 4.12</p>	<p>&lt;Condition&gt; Humidity Test: According to IEC60384-4 No.4.12 methods, capacitor shall be exposed for 1000±8 hours in an atmosphere of 90~95%R H .at 60±3°C, the characteristic change shall meet the following requirement. &lt;Criteria&gt;</p> <table border="1" data-bbox="396 1657 1253 1860"> <tr> <td>Leakage current</td> <td>Not more than the specified value</td> </tr> <tr> <td>Capacitance Change</td> <td>Within ± 20% of initial value.</td> </tr> <tr> <td>tan δ</td> <td>Not more than 120% of the specified value</td> </tr> <tr> <td>Appearance</td> <td>There shall be no leakage of electrolyte.</td> </tr> </table>	Leakage current	Not more than the specified value	Capacitance Change	Within ± 20% of initial value.	tan δ	Not more than 120% of the specified value	Appearance	There shall be no leakage of electrolyte.
Leakage current	Not more than the specified value								
Capacitance Change	Within ± 20% of initial value.								
tan δ	Not more than 120% of the specified value								
Appearance	There shall be no leakage of electrolyte.								

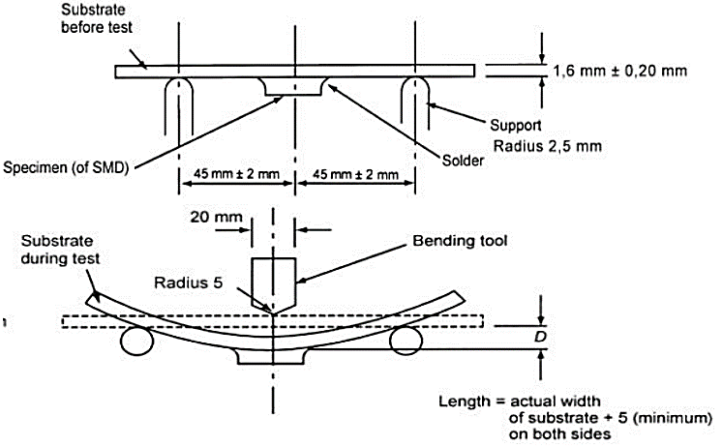

ITEM	PERFORMANCE																													
Change Of Temperature Test IEC-60384-4 4.7	<p>&lt;Condition&gt;            Temperature cycle: According to IEC60384-4 No.4.7 methods, capacitor shall be placed in an oven, the condition according as below</p> <table border="1" style="width: 100%; border-collapse: collapse; margin: 10px 0;"> <thead> <tr> <th style="width: 10%;">No.</th> <th style="width: 40%;">Temperature</th> <th style="width: 50%;">Time</th> </tr> </thead> <tbody> <tr> <td style="text-align: center;">1</td> <td style="text-align: center;">+25°C</td> <td style="text-align: center;">≤3 Minutes</td> </tr> <tr> <td style="text-align: center;">2</td> <td style="text-align: center;">-55°C</td> <td style="text-align: center;">30 ± 2 Minutes</td> </tr> <tr> <td style="text-align: center;">3</td> <td style="text-align: center;">+25°C</td> <td style="text-align: center;">≤3 Minutes</td> </tr> <tr> <td style="text-align: center;">4</td> <td style="text-align: center;">+105°C</td> <td style="text-align: center;">30 ± 2 Minutes</td> </tr> <tr> <td style="text-align: center;">5</td> <td style="text-align: center;">+25°C</td> <td style="text-align: center;">≤3 Minutes</td> </tr> <tr> <td colspan="3" style="text-align: center;">1 to 5 = 1 cycle, Total 5 cycles</td> </tr> </tbody> </table> <p>and then the capacitor shall be subjected to standard atmospheric conditions for 4 hours, after which measurements shall be made.</p> <p>&lt;Criteria&gt;            The characteristic shall meet the following requirements.</p> <table border="1" style="width: 100%; border-collapse: collapse; margin: 10px 0;"> <tbody> <tr> <td style="width: 50%;">Capacitance Change</td> <td>Within ± 10% of initial value.</td> </tr> <tr> <td>tan δ</td> <td>Not more than the specified value.</td> </tr> <tr> <td>Leakage current</td> <td>Not more than the specified value.</td> </tr> <tr> <td>Appearance</td> <td>No broken and undamaged.</td> </tr> </tbody> </table>	No.	Temperature	Time	1	+25°C	≤3 Minutes	2	-55°C	30 ± 2 Minutes	3	+25°C	≤3 Minutes	4	+105°C	30 ± 2 Minutes	5	+25°C	≤3 Minutes	1 to 5 = 1 cycle, Total 5 cycles			Capacitance Change	Within ± 10% of initial value.	tan δ	Not more than the specified value.	Leakage current	Not more than the specified value.	Appearance	No broken and undamaged.
No.	Temperature	Time																												
1	+25°C	≤3 Minutes																												
2	-55°C	30 ± 2 Minutes																												
3	+25°C	≤3 Minutes																												
4	+105°C	30 ± 2 Minutes																												
5	+25°C	≤3 Minutes																												
1 to 5 = 1 cycle, Total 5 cycles																														
Capacitance Change	Within ± 10% of initial value.																													
tan δ	Not more than the specified value.																													
Leakage current	Not more than the specified value.																													
Appearance	No broken and undamaged.																													
Low Temperature Test	<p>&lt;Condition&gt;            Capacitors are placed at -55 ± 3°C for 96 ± 4 hours. And then the capacitor shall be subjected to standard atmospheric conditions for 4 hours, after which measurements shall be made.</p> <p>&lt;Criteria&gt;</p> <table border="1" style="width: 100%; border-collapse: collapse; margin: 10px 0;"> <tbody> <tr> <td style="width: 50%;">Leakage current</td> <td>Not more than the specified value</td> </tr> <tr> <td>Capacitance Change</td> <td>Within ± 10% of initial value.</td> </tr> <tr> <td>tan δ</td> <td>Not more than the specified value.</td> </tr> <tr> <td>Appearance</td> <td>No broken and undamaged</td> </tr> </tbody> </table>	Leakage current	Not more than the specified value	Capacitance Change	Within ± 10% of initial value.	tan δ	Not more than the specified value.	Appearance	No broken and undamaged																					
Leakage current	Not more than the specified value																													
Capacitance Change	Within ± 10% of initial value.																													
tan δ	Not more than the specified value.																													
Appearance	No broken and undamaged																													

ITEM	PERFORMANCE				
<p>Vent Test IEC-60384-4 4.16</p>	<p>&lt;Condition&gt;</p> <p>The following test only apply to those products with vent products at diameter <math>\geq \varnothing 8</math> with vent.</p> <p>D.C. test</p> <p>The capacitor is connected with its polarity reversed to a DC power source. Then a current selected from following table is applied.</p> <table border="1" style="margin: 10px auto; border-collapse: collapse;"> <thead> <tr> <th style="padding: 5px;">Diameter (mm)</th> <th style="padding: 5px;">DC Current (A)</th> </tr> </thead> <tbody> <tr> <td style="padding: 5px;">22.4 or less</td> <td style="padding: 5px;">1</td> </tr> </tbody> </table> <p>&lt;Criteria&gt;</p> <p>No emission of gas after 30 minutes of the voltage application also meets the specification. The vent shall operate with no dangerous conditions such as flames or dispersion of pieces of the capacitor and/or case.</p>	Diameter (mm)	DC Current (A)	22.4 or less	1
Diameter (mm)	DC Current (A)				
22.4 or less	1				
<p>Mechanical Characteristics Test</p>	<p>&lt;Condition&gt;</p> <p>Bending Test: Apply pressure in the direction of the arrow at a rate of about 0.5 mm/s until bent width reaches 2 mm and hold for 60s. The board shall be the test board "B" as specified in JIS C 0051: 2002. If the land area differs, it shall be specified clearly in the next item.</p> <div style="text-align: center; margin: 10px 0;">  </div> <p>&lt;Criteria&gt;</p> <p>Without mechanical damage such as breaks. Electrical characteristics shall be satisfied.</p> <p>If there are electrodes on both surfaces, above requirements shall be satisfied on whichever surface it may be fixated on.</p>				

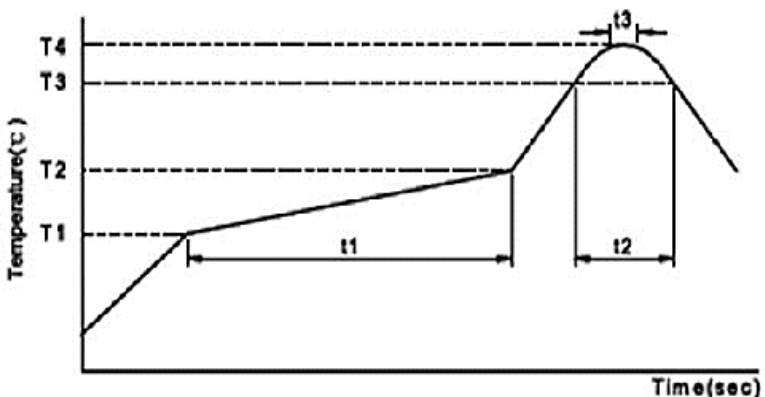
ITEM	PERFORMANCE			
Reflow Soldering  Temperature Profile	Welding Method	Reflow Soldering	Soldering Iron	Wave Soldering
	The feasibility of	○ Feasible	○ Feasible	⊗ Is not workable
<p>Conditions for the use of lead-free reflow soldering.</p> 				
<p>1) Methods the following            Reflow soldering: please follow the temperature condition during welding. If high temperature is used, please measure and inform the capacitor temperature and reflow soldering condition. The product size is larger and its rising temperature is slower. It is not necessary to adjust the temperature of the reflow solder in accordance with the size of the product. For example, the products of 4 and 10 will be installed in the PCB over tin furnace.</p> <p>2) Precautions for soldering tin: Related factors of reflow soldering temperature:            Product size: The product size is larger and its temperature rises slowly.            Product installation position: The temperature of PCB center is lower than that of PCB</p> <p>3) Reflow soldering            If possible, avoid reflow soldering twice.            If repeated reflux is unavoidable, measure and inform the first and second reflux temperature, and the time of reflow soldering</p> <p>4) Please do not 3 times of reflow soldering            Please follow the following conditions when soldering tin soldering:            Soldering iron maximum temperature: <math>350 \pm 5^{\circ}\text{C}</math>;            Welding time: 3+1/-0S</p>				

ITEM	PERFORMANCE																																																																																
Reflow Soldering  Temperature Profile	<p>Test Method And Peak Temperature Permissible Range</p> <table border="1" style="width: 100%; border-collapse: collapse; margin-bottom: 10px;"> <tr> <td colspan="2">Products category</td> <td colspan="6">SMD aluminum electrolytic capacitor</td> </tr> <tr> <td colspan="2">voltage (V)</td> <td>4~50</td> <td>4~50</td> <td>≥63</td> <td>4~100</td> <td colspan="2">≥160</td> </tr> <tr> <td colspan="2">Product size</td> <td>Φ4~6.3 3×4.5 L</td> <td>Φ4~6.3</td> <td>Φ4~6.3</td> <td colspan="2">Φ8~18</td> <td>≥Φ12.5</td> </tr> <tr> <td rowspan="2">Preheating</td> <td>TEM (T<sub>1</sub>~T<sub>2</sub>, °C)</td> <td colspan="6">150~180</td> </tr> <tr> <td>Time (t<sub>1</sub>) Max, S</td> <td>120</td> <td colspan="5">180</td> </tr> <tr> <td rowspan="2">The duration of the</td> <td>TEM (T<sub>3</sub>, °C)</td> <td>230</td> <td>217</td> <td>230</td> <td>217</td> <td>217</td> <td>230</td> <td>217</td> </tr> <tr> <td>Time (t<sub>2</sub>) Max, S</td> <td>30</td> <td>90</td> <td>60</td> <td>60</td> <td>60</td> <td>40</td> <td>60</td> </tr> <tr> <td rowspan="2">The highest temperature</td> <td>TEM (T<sub>4</sub>, °C)</td> <td>250</td> <td colspan="2">260</td> <td>250</td> <td colspan="2">250</td> <td>240</td> </tr> <tr> <td>Time (t<sub>3</sub>) Max, S</td> <td colspan="6">5</td> </tr> <tr> <td colspan="2">Return the number</td> <td>1</td> <td colspan="5">≤2</td> </tr> </table> <ul style="list-style-type: none"> <li>Please contact us if the conditions of use are higher than those listed above.</li> <li>When performing second reflow soldering, please make sure the temperature of capacitor has cooled to 5 ~ 35 °C.</li> <li>If the reflow condition is based on IPC/JEDEC(J-STD-020), please contact us.</li> </ul> <p>OP-CAP Precautions:</p> <ul style="list-style-type: none"> <li>Reflow soldering will reduce the rated electrostatic capacity of the product, and it should be confirmed whether reflow soldering condition meets the specification of recommended reflow soldering.</li> <li>Although the actual reflow condition change is still based on the reflow soldering method, please note that the highest temperature and the electrode terminal at the bottom of the aluminum shell must not exceed the maximum temperature.</li> <li>OP-CAP products during the process of reflow heating temperature should increase to more than 200 °C</li> <li>If the reflow condition temperature or duration is greater than the above table, the OP-CAP product will be damaged. The electrostatic capacity of the product is reduced by about 50%, the leakage current is large (up to mA), and the outside of the capacitor is damaged.</li> </ul> <p>Recommended Land Size (see page 5)</p>	Products category		SMD aluminum electrolytic capacitor						voltage (V)		4~50	4~50	≥63	4~100	≥160		Product size		Φ4~6.3 3×4.5 L	Φ4~6.3	Φ4~6.3	Φ8~18		≥Φ12.5	Preheating	TEM (T <sub>1</sub> ~T <sub>2</sub> , °C)	150~180						Time (t <sub>1</sub> ) Max, S	120	180					The duration of the	TEM (T <sub>3</sub> , °C)	230	217	230	217	217	230	217	Time (t <sub>2</sub> ) Max, S	30	90	60	60	60	40	60	The highest temperature	TEM (T <sub>4</sub> , °C)	250	260		250	250		240	Time (t <sub>3</sub> ) Max, S	5						Return the number		1	≤2				
Products category		SMD aluminum electrolytic capacitor																																																																															
voltage (V)		4~50	4~50	≥63	4~100	≥160																																																																											
Product size		Φ4~6.3 3×4.5 L	Φ4~6.3	Φ4~6.3	Φ8~18		≥Φ12.5																																																																										
Preheating	TEM (T <sub>1</sub> ~T <sub>2</sub> , °C)	150~180																																																																															
	Time (t <sub>1</sub> ) Max, S	120	180																																																																														
The duration of the	TEM (T <sub>3</sub> , °C)	230	217	230	217	217	230	217																																																																									
	Time (t <sub>2</sub> ) Max, S	30	90	60	60	60	40	60																																																																									
The highest temperature	TEM (T <sub>4</sub> , °C)	250	260		250	250		240																																																																									
	Time (t <sub>3</sub> ) Max, S	5																																																																															
Return the number		1	≤2																																																																														

## APPLICATION GUIDELINE

### CIRCUIT DESIGN

1) Please make sure the environmental and mounting conditions to which the capacitor will be exposed are within the conditions specified in catalogue.

2) Operating temperature and applied ripple shall be within specification.

3) Appropriate capacitors which comply with the life requirement of the products should be selected when designing the circuit.

4) Aluminum electrolytic capacitors are polar. Make sure that no reverse voltage or AC voltage is applied to the capacitors. Please use bi-polar capacitors for a circuit that can possibly see reversed polarity.

Note: Even bi-polar capacitors cannot be used for AC voltage application.

5) Do not use aluminum electrolytic capacitors in a circuit that requires rapid and very frequent charge/ discharge. In this type of circuit, it is necessary to use a special design capacitor with extended life characteristics.

6) Do not apply excess voltage.

(1) Please pay attention to that the peak voltage, which is DC voltage overlapped by ripple current, will not exceed the rated voltage.

(2) In the case where more than 2 aluminum electrolytic capacitors are used in series, please make sure that applied voltage will be lower than rated voltage and the voltage will be applied to each capacitor equally by using a balancing resistor in parallel with the capacitor.

7) Aluminum electrolytic capacitors shall not be used under the following environmental conditions:

(1) (a) Capacitors will be exposed to water (including condensation), brine or oil. (b) Ambient conditions that include toxic gases such as hydrogen sulfide, sulfurous acid, nitrous acid, chlorine, bromine, methyl bromide, ammonium, etc. (c) Ambient conditions that expose the capacitor to ozone, ultraviolet ray and radiation.

(2) Severe vibration and physical shock conditions that exceed specification.

Vibration test condition: 10-55-10Hz

Vibration frequency range : 10~55~10hz

Sweep rate : 10~55~10Hz/minute

Sweep method : logarithmic

Amplitude or acceleration : 1.5mm (max. Acceleration is 10G)

Direction of vibration : X, Y, Z direction

Testing time: 2 hours per each direction

Shock is not applicable normally.

If a particular condition is required, please contact our sales team.

8) The main chemical solution of the electrolyte and the separator paper used in the capacitors are combustible.

The electrolyte is conductive. When it comes in contact with the PC board, there is a possibility of pattern corrosion or short circuit between the circuit pattern, which could result in smoking or catching fire. Do not locate any circuit pattern beneath the capacitor end seal.

9) Do not design a circuit board that the heat generating components are placed near the aluminum electrolytic capacitor or on the reverse side of PC board, if that just under the capacitor.

10) Electrical characteristics may vary depending on changes in temperature and frequency. Please consider this variation when you design circuits.

11) When you install more than 2 capacitors in parallel, please consider the balance of current flowing into the capacitors.

12) While mounting capacitors on double-side PC board, the capacitors should be away from those unnecessary base plate holes and connection holes.

#### MOUNTING

1) Once a capacitor has been assembled in the set and power applied, do not attempt to re-use the capacitor in other circuits or application.

2) Leakage current of the capacitors that have been stored for more than 2 years may increase. When leakage current has increased, please perform a voltage treatment using a 1kΩ resistor.

3) Please confirm specifications and polarity before installing capacitors on the PC board.

4) Do not drop capacitors on the floor, nor use a capacitor that was dropped.

5) Do not deform the capacitor during installation.

6) Please pay attention to the mechanical shock to the capacitor by suction nozzle of the automatic insertion machine or automatic mounter, or by product checker, or by centering mechanism.

#### REFLOW SOLDERING

1) Please follow "Reflow Soldering Conditions" when use the part.

2) When an infrared heater is used, please pay attention to the extent of heating since the absorption rate of infrared will vary due to difference in the color and size of the capacitor.

3) Do not tilt lay down or twist the capacitor body after the capacitor are soldered to the PC board.

4) Do not carry the PC board by grasping the soldered capacitor.

5) Please do not allow anything to touch the capacitor after soldering. If PC boards are stored in stack, please make sure the PC board or other components away from the capacitor.

6) The capacitors shall not be effected by any radiated heat from the soldered PC board or other components after soldering.

7) Cleaning:

(a) Do not clean capacitors with halogenated cleaning agent. However, if it is necessary to clean with halogenated cleaning agent, please contact our sales team.

(b) Recommended cleaning method

Applicable : Any type, any ratings

Cleaning conditions: Total cleaning time shall be within 2 minutes by immersion, ultrasonic or other methods.

Temperature of the cleaning agents shall be 40°C or below. After cleaning, capacitors should be dried by using hot air for the minimum 10 minutes along with the PC board mounted. Hot air temperature should be within the maximum operating temperature of the capacitor. Insufficient dryness after water rinse may cause appearance problems, such as bottom-plate bulge and etc.;

Avoid using ozone destructive substances as cleaning agents for protecting global environment.

#### IN THE EQUIPMENT

1) Do not directly touch terminal by hand.

2) Do not link positive terminal and negative terminal by conductor, nor spill conductible liquid such as alkaline or acidic solution on or near the capacitor.

3) Please make sure that the ambient conditions where the set is installed are free from spilling water or oil, direct sunlight, ultraviolet rays, radiation, poisonous gases, vibration or mechanical shock.

#### MAINTENANCE AND INSPECTION

Please periodically inspect the aluminum capacitors that are installed in industrial equipment. The following items should be checked:

Appearance: remarkable abnormality such as pressure relief vent opening, electrolyte leaking, etc.

Electrical characteristics: capacitance, dielectric loss tangent, leakage current and etc., which are specified in catalogue or alternate product specification.

#### IN AN EMERGENCY

1) If you see smoke due to operation of safety vent, please turn off the main switch or pull out the plug from the outlet.

2) If you breathe the gas or ingest the electrolyte, please wash out your mouth and throat with water immediately.

3) If your skin is exposed to the electrolyte, please wash it away using soap and water.

#### STORAGE

1) Do not keep capacitor in high temperature and high humidity atmosphere. Storage conditions should be:

Temperature: 5°C~ 35°C Humidity : lower than 75% Place : Indoor

2) Avoid ambient conditions where capacitors are covered with water, brine or oil.

3) A storage products for longer than 12 months is not recommended. Within other effects, the terminals may suffer degradation, resulting in bad solderability. All products shall be used within the period of 12 months based on the day of shipment

#### DISPOSAL

Please take either of the following methods in disposing capacitors.

1) Incinerate them after crushing capacitors or making a hole on the capacitor body.

2) If incineration is not applicable, hand them over to a waste disposal agent and have them buried in landfills.



TAPE (Unit: mm), Applicable standard JIS C0806 and IEC 60286.

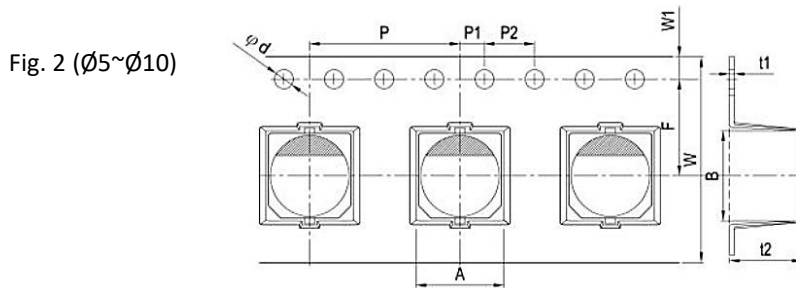
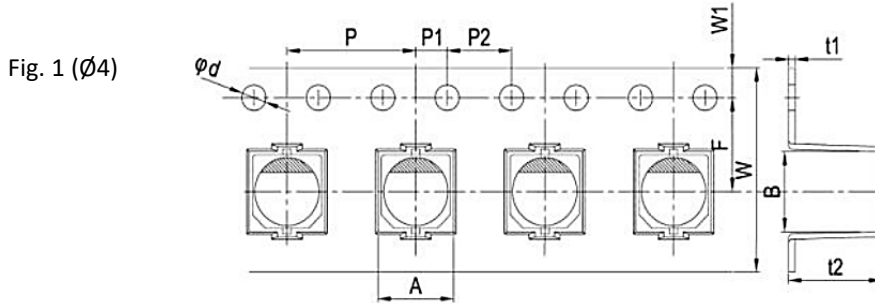

SIZE	W	P	F	A0	B0	t2	$\phi d$	P1	P2	t1	W1	APPLICABLE
$\phi 4 * 5.7$	12	8	5.5	4.7	4.7	5.8	1.5	2	4	0.4	1.75	Fig.1
$\phi 5 * 5.7$	12	12	5.5	6.0	6.0	5.8	1.5	2	4	0.4	1.75	Fig.2
$\phi 6.3 * 5.7$	16	12	7.5	7.0	7.0	5.8	1.5	2	4	0.4	1.75	Fig.2
$\phi 6.3 * 7.7$	16	12	7.5	7.0	7.0	8.3	1.5	2	4	0.4	1.75	Fig.2
$\phi 8 * 6.5$	16	12	7.5	8.7	8.7	6.8	1.5	2	4	0.4	1.75	Fig.2
$\phi 8 * 10.5$	24	16	11.5	8.7	8.7	11.0	1.5	2	4	0.4	1.75	Fig.2
$\phi 8 * 12.5$	24	16	11.5	8.7	8.7	13.0	1.5	2	4	0.4	1.75	Fig.2
$\phi 10 * 10.5$	24	16	11.5	10.7	10.7	11.0	1.5	2	4	0.4	1.75	Fig.2
$\phi 10 * 12.5$	24	16	11.5	10.7	10.7	13.0	1.5	2	4	0.4	1.75	Fig.2
$\phi 10 * 13.5$	24	16	11.5	10.7	10.7	13.0	1.5	2	4	0.4	1.75	Fig.2

TAPE (Unit: mm), Applicable standard JIS C0806 and IEC 60286.

Fig. 3 (Ø12.5)

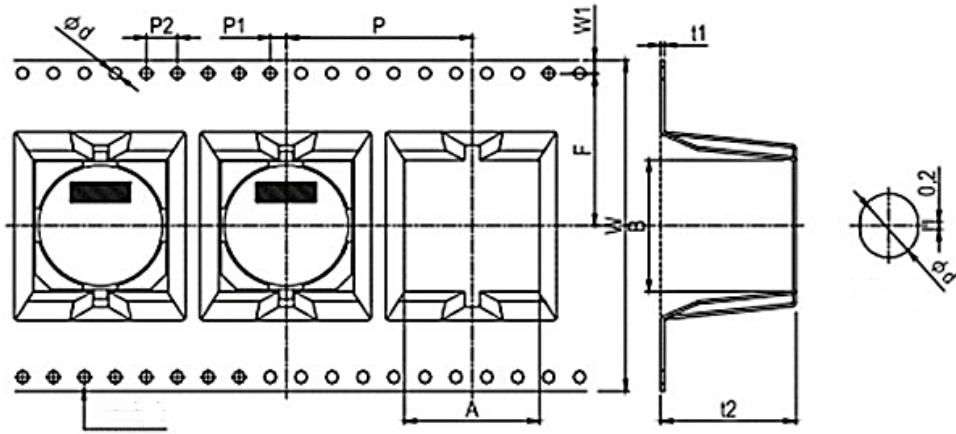

SIZE	W	P	F	A	B	t2	$\phi d$	P1	P2	t1	W1	APPLICABLE
Ø12.5*13.5	32	24	14.2	13.4	13.4	14.5	1.5	2	4	0.5	1.75	Fig.3

REEL (Unit: mm), Applicable standard JIS C0806 and IEC 60286.

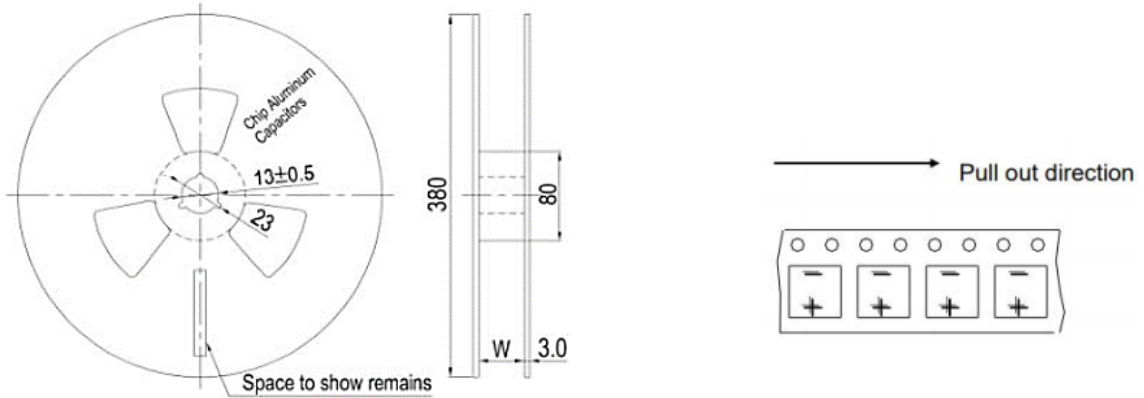

CASE SIZE	Ø4	Ø5	Ø6.3	Ø8x6.5	Ø8x10.5	Ø10	Ø12.5
W (mm)	14	14	18	18	26	26	34
Qty/Reel (pcs)	2000	1000	1000	500	500	500	200

### PACKING METHOD

- Polarity: Anode on the opposite side of the feed hole
- The leader length of the tape shall not be less than 400mm including 10 or more embossed sections in which no parts are contained.
- The winding core is provided with an over 40mm long empty section

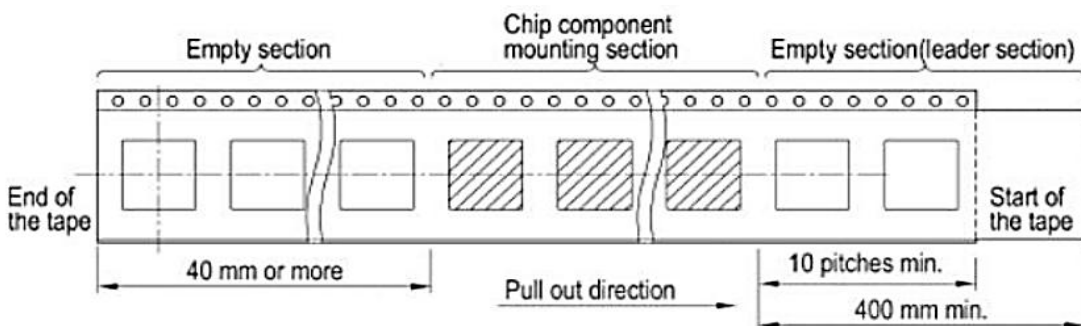

## IMPORTANT NOTES AND DISCLAIMER

### *RoHS Compliance*

This product complies with EU RoHS Directive 2011/65/EU and its amendment (EU) 2015/863 (RoHS 3). Restricted substances are below applicable threshold limits or permitted under exemptions. RoHS documentation is available upon request.

### *REACH Compliance*

Information regarding Substances of Very High Concern (SVHCs) under REACH is available. As the European Chemicals Agency (ECHA) periodically updates the SVHC list, customers should obtain the latest information prior to use.

### *Product Performance*

All parametric performance data is specified under the electrical characteristics and corresponding test conditions provided herein, unless otherwise noted. Performance may vary if operated outside specified conditions.

### *Specifications and Changes*

NextGen Components, Inc. ("NextGen") reserves the right to modify this document and the products described herein at any time without prior notice. Customers are responsible for verifying the most current product information prior to final design, purchase, or use.

### *Cross-Reference*

Cross-reference information is provided for reference purposes only and does not imply direct equivalence, endorsement, or guaranteed interchangeability. Customers are solely responsible for verifying electrical, mechanical, and environmental suitability for their specific applications. *NextGen* assumes no liability arising from product substitution or application-specific use.

### *Warranty and Limitation of Liability*

*NextGen* makes no representation or warranty, express or implied, regarding suitability for any particular purpose. *NextGen* shall not be liable for any indirect, incidental, consequential, or special damages arising from product use. No license is granted under any intellectual property rights of *NextGen*.

### *Restricted Applications*

*NextGen* products are not authorized for use as critical components in life-support devices, medical systems, or other safety-critical applications without prior written approval.

### *Returns Policy*

Customers must obtain a Returned Merchandise Authorization (RMA) number before returning products. Returns must be requested within 30 days of invoice date and products must be unused and in original packaging. Products designated as Non-Cancelable / Non-Returnable (NCNR) are not eligible for return.