

SPECIFICATION SHEET NO.	T0304- RC40M00000S302	
ORIGINAL MFR. PART NO.	TGS Crystals –TGS COM7531AGI01TLF-40M000	
NEXTGEN ORDER PART NO.	RC40M00000S302	This number is required on all RFQs and Purchase Orders
RELEASE DATE	Mar. 04, 2026	
REVISION	Rev. A5	Updated to reflect the most recent data
DESCRIPTION AND KEY SPECIFICATIONS FOR SINGLE PART NUMBER	<p>Industrial Grade SMD Crystal Oscillator, RC Series – 7050 Package</p> <p>Nominal Frequency: 40.00 MHz, Supply Voltage: 3.3 V ±10%</p> <p>Frequency Stability: ±25 ppm @ 25 ± 3 °C</p> <p>Duty Cycle: 45% – 55%</p> <p>Output Type: HCMOS, Output Load: 15 pF</p> <p>Tri-State (Output Enable) Via Pin 1</p> <p>Operating Temperature Range: -40 °C to +85 °C</p> <p>Package Dimensions: 7.0 × 5.0 × 1.3 mm</p> <p>Storage Temperature Range: -55 °C to +125 °C</p> <p>Packaging: Tape & Reel, 1000 pcs per reel</p> <p>Compliance: RoHS REACH Pb-Free</p>	
CUSTOMER		
CUSTOMER PART NO.		
NOTE		

VENDOR APPROVAL

Prepared by | Checked by | Approved by



Date: Mar. 04, 2026

CUSTOMER APPROVAL

Signature:

Name:

Title:

Date:

GENERAL DESCRIPTION

The RC Series 7050 is a 7.0 × 5.0 × 1.3 mm industrial-grade SMD crystal oscillator designed for stable frequency applications.



MAIN FEATURES

- SMD Package, Seam Sealed, 7050 Type, 4 Pads
- Package Dimensions: 7.0 × 5.0 × 1.3 mm
- Low Noise and Low Current Consumption
- Industry Standard
- Reflow Profile: 260 ° C Maximum
- Tri-state Function – Enable/Disable or Tri-State (Output Enable) Via Pin 1
- Compatible with competitive industry-standard parts.
- REACH and RoHS (2011/65/EU & 2015/863/EU) compliant

The image shown is for reference only. Please refer to the dimensional drawing for exact mechanical specifications.

APPLICATIONS

- Industrial Equipment
- Data Communications
- Communication Equipment
- Automotive Electronics



ELECTRICAL CHARACTERISTICS

- Refer to Page 3-7 for detailed electrical characteristics.

IMPORTANT NOTICE

- Specifications are subject to change without prior notice.
- NextGen reserves the right to modify product specifications at any time without liability. Customers are responsible for verifying the most current product information prior to design, purchase, or use.
- All parameters and performance data are subject to final confirmation by NextGen.

GENERAL ELECTRICAL CHARACTERISTICS – RC SERIES

Standard Atmospheric Conditions for Measurement

Unless otherwise specified, the standard atmospheric conditions for measurements and tests are as follows:

Ambient temperature: $25 \pm 3 \text{ }^\circ\text{C}$

Relative humidity: 40% – 70%

In case of dispute, measurements shall be conducted under the following conditions:

Ambient temperature: $25 \pm 3 \text{ }^\circ\text{C}$

Relative humidity: 40% – 70%

Model OSC-7050

Cutting Mode AT CUT

PARAMETER	SYMBOL	VALUE			UNIT	CONDITION
		MIN.	TYPE	MAX.		
Frequency Range	F0	0.032768	-	125.00	MHz	
Frequency Tolerance	$\Delta F/F0$	± 20	-	± 50	ppm	at $25^\circ\text{C} \pm 3^\circ\text{C}$
Supply Voltage	VDD	1.65	-	5.0	V	
Output Load	CL	15, 30, 50			pF	
Output Type (CMOS Logic Levels)		TTL, HCMOS				
Aging	FA	-	± 3	-	ppm	1st Year at $25 \text{ }^\circ\text{C}$
Operating Temp. Range	TOPR	-40	-	85	$^\circ\text{C}$	
Storage Temp. Range	TSTG	-55	-	125	$^\circ\text{C}$	
Current Consumption	IDD	-	-	25	mA	
Standby Current	IST	-	-	10	μA	
Output Voltage High	VOH	2.97	-	-	V	
Output Voltage Low	VOL	-	-	0.33	V	
Duty Cycle	Duty	45	-	55	%	
Start-up Time	Tosc	-	-	10	ms	
Rise/ Fall time	Tr/Tf	-	-	8	ns	10% – 90%VDD Level
Tri-state Function	INH N	Enable/Disable or Tri-State (Output Enable) Via Pin 1				
Enable Voltage High	VIH	2.31	-	-	V	
Disable Voltage Low	VIL	-	-	0.99	V	

STANDARD PART NUMBERS – RC SERIES (Ta = 25 °C)

Part Code	Frequency Range	Supply Voltage	Frequency Stability	Output Type	Output Load	Tri-State Function
	MHz	V	ppm @ 25 °C		pF	
RC1M000000S302	1.000000	3.3	±25	HCMOS	15	Tri-State (Output Enable)
RC2M000000S302	2.000000	3.3	±25	HCMOS	15	Tri-State (Output Enable)
RC2M048000S302	2.048000	3.3	±25	HCMOS	15	Tri-State (Output Enable)
RC2M048000S300	2.048000	3.3	±50	HCMOS	15	Tri-State (Output Enable)
RC2M048000S002	2.048000	3.3	±50	TTL	15	Enable/Disable
RC4M000000S302	4.000000	3.3	±25	HCMOS	15	Tri-State (Output Enable)
RC4M096000S302	4.096000	3.3	±25	HCMOS	15	Tri-State (Output Enable)
RC6M000000S302	6.000000	3.3	±25	HCMOS	15	Tri-State (Output Enable)
RC8M000000S302	8.000000	3.3	±25	HCMOS	15	Tri-State (Output Enable)
RC9M375000S100	9.375000	3.3	±50	TTL	15	Enable/Disable
RC10M00000S502	10.00000	5.0	±25	HCMOS	15	Tri-State (Output Enable)
RC10M00000S302	10.00000	3.3	±25	HCMOS	15	Tri-State (Output Enable)
RC11M05920S302	11.05920	3.3	±25	HCMOS	15	Tri-State (Output Enable)
RC11M28960S302	11.28960	3.3	±25	HCMOS	15	Tri-State (Output Enable)
RC12M00000S302	12.00000	3.3	±25	HCMOS	15	Tri-State (Output Enable)
RC12M28800S302	12.28800	3.3	±25	HCMOS	15	Tri-State (Output Enable)
RC14M31818S302	14.31818	3.3	±25	HCMOS	15	Tri-State (Output Enable)
RC14M74560S302	14.74560	3.3	±25	HCMOS	15	Tri-State (Output Enable)
RC15M00000S302	15.00000	3.3	±25	HCMOS	15	Tri-State (Output Enable)
RC16M00000S302	16.00000	3.3	±25	HCMOS	15	Tri-State (Output Enable)

STANDARD PART NUMBERS – RC SERIES (Ta = 25 °C)

Part Code	Frequency Range	Supply Voltage	Frequency Stability	Output Type	Output Load	Tri-State Function
	MHz	V	ppm @25°C		pF	
RC20M00000S302	20.00000	3.3	±25	HCMOS	15	Tri-State (Output Enable)
RC20M00000S300	20.00000	3.3	±50	HCMOS	15	Tri-State (Output Enable)
RC20M48000S001	20.48000	3.3	±50	TTL	15	Enable/Disable
RC20M48000S100	20.48000	5.0	±25	HCMOS	15	Tri-State (Output Enable)
RC22M11840S302	22.11840	3.3	±25	HCMOS	15	Tri-State (Output Enable)
RC24M00000S302	24.00000	3.3	±25	HCMOS	15	Tri-State (Output Enable)
RC24M00000S300	24.00000	3.3	±50	HCMOS	15	Tri-State (Output Enable)
RC24M57600S302	24.57600	3.3	±25	HCMOS	15	Tri-State (Output Enable)
RC24M57600S100	24.57600	3.3	±50	TTL	15	Enable/Disable
RC25M00000S502	25.00000	5.0	±25	HCMOS	15	Tri-State (Output Enable)
RC25M00000S302	25.00000	3.3	±25	HCMOS	15	Tri-State (Output Enable)
RC25M00000S300	25.00000	3.3	±50	HCMOS	15	Tri-State (Output Enable)
RC26M00000S302	26.00000	3.3	±25	HCMOS	15	Tri-State (Output Enable)
RC27M00000S302	27.00000	3.3	±25	HCMOS	15	Tri-State (Output Enable)
RC27M00000S300	27.00000	3.3	±50	HCMOS	15	Tri-State (Output Enable)
RC30M00000S302	30.00000	3.3	±25	HCMOS	15	Tri-State (Output Enable)
RC32M00000S302	32.00000	3.3	±25	HCMOS	15	Tri-State (Output Enable)
RC32M76800S302	32.76800	3.3	±25	HCMOS	15	Tri-State (Output Enable)
RC33M00000S302	33.00000	3.3	±25	HCMOS	15	Tri-State (Output Enable)
RC33M79200S001	33.79200	3.3	±25	TTL	15	Tri-State (Output Enable)

STANDARD PART NUMBERS – RC SERIES (Ta = 25 °C)

Part Code	Frequency Range	Supply Voltage	Frequency Stability	Output Type	Output Load	Tri-State Function
	MHz	V	ppm @25°C		pF	
RC34M36800S302	34.36800	3.3	±25	HCMOS	15	Tri-State (Output Enable)
RC34M56000S302	34.56000	3.3	±25	HCMOS	15	Tri-State (Output Enable)
RC40M00000S302	40.00000	3.3	±25	HCMOS	15	Tri-State (Output Enable)
RC40M00000S300	40.00000	3.3	±50	HCMOS	15	Tri-State (Output Enable)
RC40M96000S001	40.96000	3.3	±50	TTL	15	Tri-State (Output Enable)
RC41M66000S001	41.66000	3.3	±50	HCMOS	15	Tri-State (Output Enable)
RC44M00000S302	44.00000	3.3	±25	HCMOS	15	Tri-State (Output Enable)
RC48M00000S502	48.00000	5.0	±25	HCMOS	15	Tri-State (Output Enable)
RC48M00000S302	48.00000	3.3	±25	HCMOS	15	Tri-State (Output Enable)
RC48M00000S300	48.00000	3.3	±50	HCMOS	15	Tri-State (Output Enable)
RC49M15200S302	49.15200	3.3	±25	HCMOS	15	Tri-State (Output Enable)
RC50M00000S302	50.00000	3.3	±25	HCMOS	15	Tri-State (Output Enable)
RC50M00000S300	50.00000	3.3	±50	HCMOS	15	Tri-State (Output Enable)
RC54M00000S302	54.00000	3.3	±25	HCMOS	15	Tri-State (Output Enable)
RC65M53600S002	65.53600	3.3	±50	TTL	15	Enable/Disable
RC66M00000S302	66.00000	3.3	±25	HCMOS	15	Tri-State (Output Enable)
RC66M66670S302	66.66670	3.3	±25	HCMOS	15	Tri-State (Output Enable)
RC66M66700S302	66.66700	3.3	±25	HCMOS	15	Tri-State (Output Enable)
RC70M65600S302	70.65600	3.3	±25	HCMOS	15	Tri-State (Output Enable)
RC75M00000S302	75.00000	3.3	±25	HCMOS	15	Tri-State (Output Enable)

SUGGESTED LAYOUT– Unit: mm, For Reference Only



CMOS LOAD OUTPUT WAVEFORM

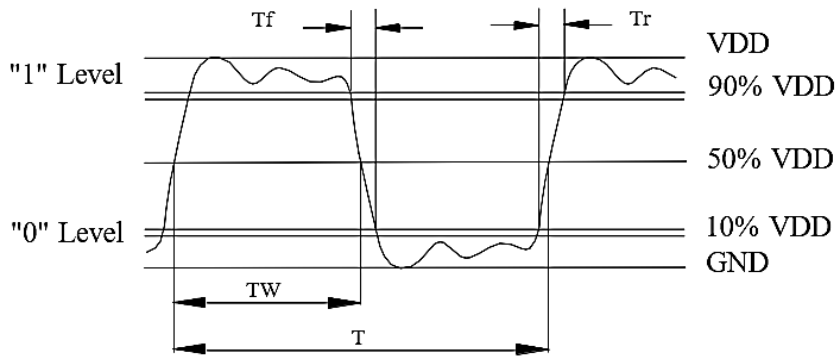

CMOS LOAD TEST CIRCUIT

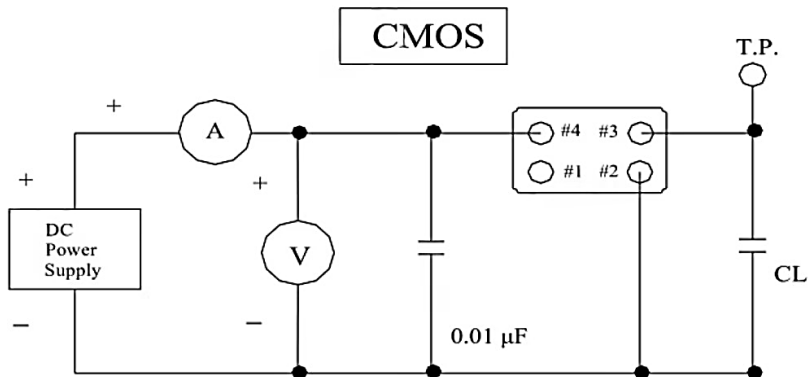

Since the RC series does not include an internal bypass capacitor,
 It is recommended that customers connect a 0.01 µF capacitor between VDD and GND.

PACKAGE DIMENSIONS - Unit: mm, 7.0 × 5.0 × 1.3 mm

Top View

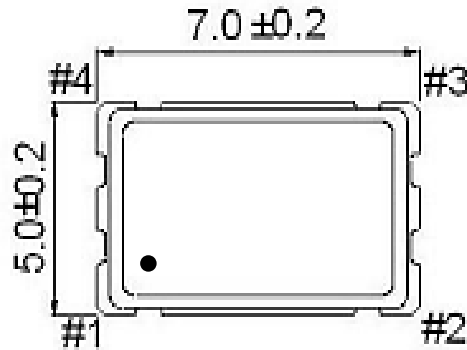

Side View



Bottom View

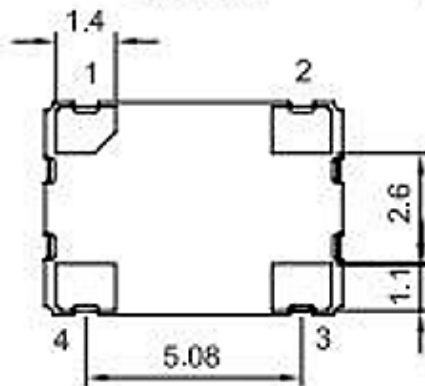

Pin Function

Pin 1: Tri-state Enable

Pin 2 GND

Pin 3 Output

Pin 4 VDD

HANDLING AND STORAGE PRECAUTIONS

TEST ITEMS	TEST METHOD AND CONDITIONS	PERFORMANCE
Drop Test	<p>The specimen is measured for its frequency and resistance before the test. It is then dropped from a height of 100 cm or more as a free fall object onto a hard wooden plate of 30mm or more in thickness.</p> <p>(in accordance with JIS-C0044)</p>	<p>Electrical performance shall meet the specified requirements.</p>
Vibration Test	<p>The specimen is measured for its frequency and resistance before the test. Mount the specimens on the X, Y, and Z axes, respectively, for the vibration test. Vibration condition:</p> <p>Frequency range: 20 – 2000 Hz</p> <ul style="list-style-type: none"> • Peak-to-peak amplitude: 1.52 mm • Peak acceleration: 20G • Sweep time: 20 minutes per axis • Perpendicular total test time: 4 hours <p>(in accordance with MIL-STD-883F: 2007.3)</p>	<p>Electrical performance shall meet the specified requirements.</p>
Resistance to Soldering Test	<p>The specimen is measured for its frequency and resistance before the test. Place the specimen on the belt of the conveyance and let it pass through the reflow with the preset temperature condition. After passing through the reflow process twice, place the specimen under reference conditions for 1–2 hours before measuring electrical performance.</p> <p>Temperature Condition of IR Simulation:</p> <p>The temperature range of the preheated section is set at 150 – 180 ° C for 60 – 120 s. For the next section the temperature range is set at 217 – 260 ° C for 45 – 90 s. Within this time range, the specimen shall be able to withstand the peak temperature, 260 ± 3 ° C, for 10 seconds.</p> <p>(in accordance with JESD22-B106-B)</p>	<p>Electrical performance shall meet the specified requirements.</p>
<p>Reference Conditions (in accordance with MIL-STD-883E: 1014.9) Temperature: 25 ± 2 °C Humidity: 44 – 55 % Pressure: 86 – 106 kPa</p>		

HANDLING AND STORAGE PRECAUTIONS

TEST ITEMS	TEST METHOD AND CONDITIONS	PERFORMANCE
Fine Leak Test	Place the specimen in a pressurized container and pressurize it with the detection gas (mixed gas consisting of 95% or more helium) for at least 2 hours. Complete the measurement of the concentration of helium within 30 min after taking it out from the pressurized container. (in accordance with MIL-STD-883F: 1014.11)	Less than 1.0×10^{-8} atm·cc/sec (Helium)
Low Temp Exposure Test	The specimen is measured for its frequency and resistance before the test . Place the specimen in the chamber and keep it at -40 ± 3 ° C for 168 ± 6 hours. Take the specimen out of the chamber and measure its electrical performance after leaving 1 – 2 hours under the reference condition. (in accordance with JIS-C0020)	Electrical performance shall meet the specified requirements.
Aging Test	The specimen is measured for its frequency and resistance before the test. Place the specimen in the testing chamber and keep it at $+125 \pm 3$ ° C for 720 ± 48 hours. And then take the specimen out of the chamber and measure its electrical performance after leaving for 1 – 2 hours under the reference condition. (in accordance with JIS-C0021)	Electrical performance shall meet the specified requirements.
High Temperature & High Humidity	The specimen is measured for its frequency and resistance before the test. Place the specimen in the testing chamber and keep it at $+85 \pm 5$ ° C and humidity of $85 \pm 5\%$ for 168 ± 6 hours. Then take the specimen out and measure its electrical performance after leaving for 1–2 hours under the reference condition. (in accordance with MIL-STD-883F: 1004.7)	Electrical performance shall meet the specified requirements.

HANDLING AND STORAGE PRECAUTIONS

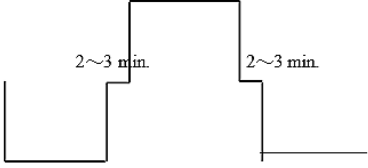
TEST ITEMS	TEST METHOD AND CONDITIONS	PERFORMANCE
<p>Temperature Cycle Test</p>	<p>The specimen is measured for its frequency and resistance before the test.</p> <p>Subject the specimen to 100 temperature cycles under the following conditions:</p> <p>High Temperature: $+125 \pm 3^{\circ} \text{C}$ ($15 \pm 3 \text{ min}$)</p>  <p>Low Temperature: $-55 \pm 3^{\circ} \text{C}$ ($15 \pm 3 \text{ min}$)</p> <p>Measure its electrical performance after leaving it for 1 – 2 hours under the reference condition.</p> <p>(in accordance with MIL-STD-883F: 1010.8)</p>	<p>Electrical performance shall meet the specified requirements.</p>

TAPE/REEL – Unit: mm

All Devices are packed in accordance with EIA standard RS-481-2 and specifications, 1000 pcs per reel

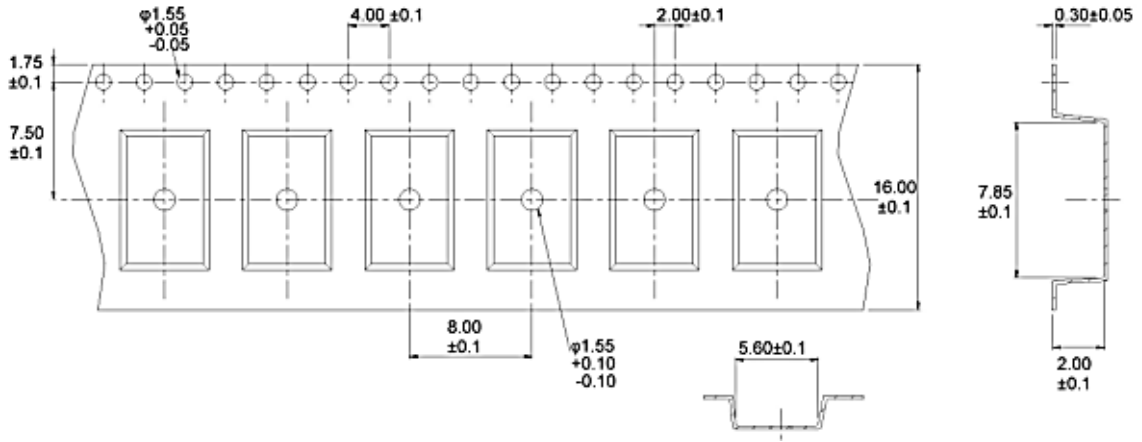

The Direction Of Packing

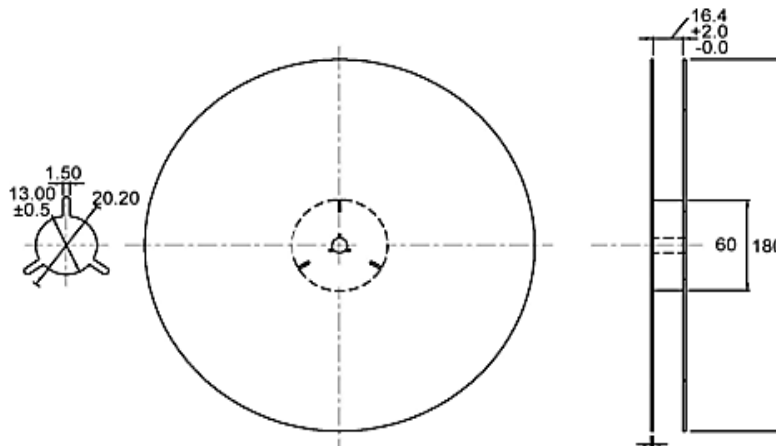

COVER TAPE ADHESION STRENGTH

- When the cover tape is peeled under the above conditions, the adhesion strength shall be:
- Plastic Tape: 10.2 g – 71.4 g



SUGGESTED REFLOW PROFILE

For Engineering Reference Only



PROFILE FEATURE		PB-FREE ASSEMBLY
Average Ramp-up Rate (T_L Max to T_p)		3 °C/s Max
Preheat	Temperature Min (T_s Min.)	150 °C
	Temperature Max (T_s Max.)	200 °C
	Time (t_s Min. to t_s Max.)	60 – 180 seconds
Time maintained above	Temperature (T_L)	217 °C
	Time (t_L)	60 – 150 seconds
Peak/Classification Temperature (T_p)		260 °C
Time within 5 °C of actual Peak Temperature (t_p)		10 seconds Max.
Ramp-down Rate		6 °C/s Max.
Time from 25 °C to Peak Temperature		8 minutes Max.
Suggest reflow times		3 times max.

ORDERING INFORMATION

- Please refer to the part numbering structure and specify the NextGen order part number RC40M00000S302 on all RFQs and Purchase Orders.

RFQ
[Request For Quotation](#)

PART NUMBERING STRUCTURE

CODE	NAME	KEY SPECIFICATION OPTION
RC	Series Code	SMD Crystal Oscillator 7050 Type, 4 Pads, Package Dimensions 7.0 × 5.0 × 1.3 mm
40M0	Frequency Range Code	40M0: 40.0 MHz or Custom Frequency Range
0000S	Internal Control Code	Letter A – Z, a – z or Digits (0 – 9)
302	Parameters Code	Special Parameters Code Letter A – Z, a – z or Digits (0-9)
XX	Special/Custom Parameters Code	Blank: N/A XX: Letter A – Z, a – z or Digits (0 – 9) for Special/Custom Parameters

IMPORTANT NOTES AND DISCLAIMER

RoHS Compliance

This product complies with EU RoHS Directive 2011/65/EU and its amendment (EU) 2015/863 (RoHS 3). Restricted substances are below applicable threshold limits or permitted under exemptions. RoHS documentation is available upon request.

REACH Compliance

Information regarding Substances of Very High Concern (SVHCs) under REACH is available. As the European Chemicals Agency (ECHA) periodically updates the SVHC list, customers should obtain the latest information prior to use.

Product Performance

All parametric performance data is specified under the electrical characteristics and corresponding test conditions provided herein, unless otherwise noted. Performance may vary if operated outside specified conditions.

Specifications and Changes

NextGen Components, Inc. (“NextGen”) reserves the right to modify this document and the products described herein at any time without prior notice. Customers are responsible for verifying the most current product information prior to final design, purchase, or use.

Warranty and Limitation of Liability

NextGen makes no representation or warranty, express or implied, regarding suitability for any particular purpose. *NextGen* shall not be liable for any indirect, incidental, consequential, or special damages arising from product use. No license is granted under any intellectual property rights of *NextGen*.

Restricted Applications

NextGen products are not authorized for use as critical components in life-support devices, medical systems, or other safety-critical applications without prior written approval.

Returns Policy

Customers must obtain a Returned Merchandise Authorization (RMA) number before returning products. Returns must be requested within 30 days of invoice date and products must be unused and in original packaging. Products designated as Non-Cancelable / Non-Returnable (NCNR) are not eligible for return.