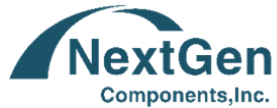



*Image shown is a representation only.
 Exact specifications should be obtained
 from the product dimension*

PRODUCT NAME:	MLCC For General Purpose C Series SMD 0603 X5R 4.7μF ±10% 25V
REVISION:	A5
NEXTGEN ORDER PART CODE*:	C0603W475K250K
CROSS REF. PART NO.:	
ORIGINAL MFG PART NO.:	C0603X5R475K250NTK
ORIGINAL MANUFACTURER:	EYang Technology/Eyang MLCC

*: Please Indicate NextGen Order Part Code For RFQ/Order Support



AUTHORIZED DISTRIBUTOR

NextGen Components, Inc.

US Warehouse Location: 9 Orchard Road, Suit 106, Lake Forest, CA 92630, USA

RFQ/Order Support: sales@NextGenComponent.com

Note: This page was created by NextGen Components, Inc. ("NextGen"). The attached last document was created by the part manufacturer, not NextGen, and is provided strictly 'as is.' NextGen, its subsidiaries, affiliates, employees, and agents make no representations or warranties regarding the attached last document and disclaim any liability for the consequences of relying on the information therein. All referenced brands, product names, service names, and trademarks are the property of their respective owners.

HOW TO ORDER

Please Follow Up Part Code Guide And Indicate NextGen Part Code C0603W475K250K For RFQ and new Order.**RFQ**
Request For Quotation

CODE	NAME	KEY SPECIFICATION OPTION
C	Series Code	C: Multilayer Ceramic Chip Capacitors For General Purpose
0603	Case Size	0105 : L0.40*W0.20mm; 0201 : L0.60*W0.30mm; 0402 : L1.00*W0.50mm; 0603 : L1.60*W0.80mm 0805 : L2.00*W1.25mm; 1206 : L3.20*W1.60mm; 1210 : L3.20*W2.50mm
W	Temperature Characteristics	N: NPO (COG); B: X7R; W: X5R; S: X6S; Y: Y5V; T: X7S; R: X7T
475	Capacitance	Two significant digits followed by number of Zero, The 3rd digit signifies the multiplying factor, and letter R is decimal point. 1R0: 1pF; 330: 33pF; 474: 470nF; 680: 68pF; 100: 10pF; 475: 4.7 μ F
K	Capacitance Tolerance	A: \pm 0.05pF; B: \pm 0.1pF; C: \pm 0.25pF; D: \pm 0.5pF; F: \pm 1%; G: \pm 2%; J: \pm 5%; K: \pm 10% L: \pm 15%; M: \pm 20%; N: \pm 30%; P: \pm 0.02pF; X: \pm 40%; S: 50%/-20%; Y: 150%/-20% Z: 80%/-20%
250	Rated Voltage	Two significant digits followed by No. of zeros. "R" is in place of decimal point. 6R3: 6.3VDC; 160: 16 VDC; 250: 25 VDC; 100: 10 VDC; 500: 50 VDC; 101: 100VDC
K	Case Thickness	K: 1.15mm Max, See Page 9 (T's Symbol) for Different part code
XX	Internal Control Code	Blank: N/A; XX: Letter A~Z, a~z or digits (0~9) for Special/Custom Parameters

Multilayer Ceramic Chip Capacitors for General Purpose
C0603X5R475K250NTK (0603,X5R, 4.7 μF,DC 25V)

1. Scope

This specification applies to Multilayer Ceramic Chip Capacitors (MLCC), specifically intended for general consumer electronics such as: smartphones/smartwatches, laptops, home appliances, wireless communication devices, among others.

2. Part Number System

C	0603	X5R	475	K	250	N	T	K
①	②	③	④	⑤	⑥	⑦	⑧	⑨
Series Code	Size Code	Temperature Characteristics	Nominal Capacitance	Capacitance Tolerance	Rated Voltage	Termination Type	Packaging Code	Thickness Code

① Series Code C-Multilayer Ceramic Chip Capacitors for General Purpose

② Size Code (Unit: mm)

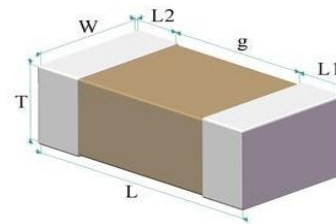

Fig.1 Structure & Dimension

Size Code	L	W	L1,L2	g	T	⑨ Thickness Code
0603	1.60 + 0.20/-0.10	0.80 + 0.20/-0.10	0.20-0.50	0.50 min	0.80 + 0.20/-0.10	K

③ Temperature Characteristics

Temperature Characteristics	Operating Temp. Range	Temperature Characteristics		
		Temp. coeff. or Cap. Change	Temp. Range	Ref. Temp.
X5R	-55 °C-85 °C	±15%	-55 °C-85 °C	25 °C

④ Nominal Capacitance

Code	Nominal Capacitance
475	4.7 μF

⑤ Capacitance Tolerance

Code	Capacitance Tolerance
K	±10%

⑥ Rated Voltage

Code	Voltage Values
250	DC 25V

⑦ Termination Type

Code	Terminal Electrodes	Plating Material
N	Cu	Ni/Sn

⑧ Packaging Code

Code	Square Hole Spacing	Disc Size	Carrier Tape	QTY (Kpcs)
T	4 mm	7"	Paper	4

3. Technical Specifications and Test Methods

1. Operating Environment

Temp. Characteristics	Temp. Range	Relative Humidity	Atmospheric Pressure
X5R	-55 °C-85 °C	≤95% (25 °C)	86 kPa-106 kPa

3.2 Reliability Test Specifications and Methods

Unless otherwise specified, the test methods in Table 1 are based on: GB/T 21041 and GB/T 21042 (IDT IEC 6038)

Table 1: Specifications and Methods

No.	Item	Specification	Test Method
1	Appearance	No obvious defects on ceramic body and termination.	Visual examination under a microscope
2	Size Code	See Fig.1 and ② Size Code	Measuring by gages which precision is not less than 0.01 mm.
3	Capacitance	Within the specified tolerance	Measurement Temperature 18 °C-28 °C Relative Humidity ≤80% RH
4	Dissipation Factor (DF)	See Table 1-2	Measurement Frequency See Table 1-2 Measurement Voltage See Table 1-2 Post-treatment When the capacitor initial capacitance is lower than its tolerance value, the test sample need to perform a heat treatment at (150 + 0/-10) °C for 1 h and then sit for (24 ± 2) h at room temperature, then measure.
5	Insulation Resistance (IR)	See Table 1-2	Measurement Temperature 18 °C-28 °C Relative Humidity ≤80% RH Measurement Voltage Rated Voltage Charging Time 1 min Charge/discharge current ≤50 mA
6	Voltage proof	No defects or abnormalities.	Test Voltage ≥2.5 × U _R Applied Time t = 1 -5 s Charge/discharge current ≤50 mA
7	Temperature characteristic of capacitance	X5R: ΔC/C ≤ ± 15%	Pre-treatment Perform heat treatment at (150 +0/- 10) °C for 1 h, then soak at room temperature for (24 ± 2) h, then measure. Measure the capacitance separately in 25 °C, θ1, 25 °C, θ2, 25 °C, should satisfied related Temperature Coefficient of Capacitance (αc) . X5R θ1 = -55 °C, θ2 = 85 °C T.C. Measurement Voltage ≤ 1.0 Vrms ※ [※ Please contact our technical support staff for more information.]
8	Resistance to soldering heat	Appearance No visible damage and terminations uncovered shall be less than 25%. Cap. Change See Table 1-3 IR Initial specification DF Initial specification Voltage proof No defects or abnormalities.	Pre-treatment Perform heat treatment at (150 +0/- 10) °C for 1 h, then soak at room temperature for (24 ± 2) h, then measure. Pre-heating 120 °C-150 °C, Time: 60 s Test Method Solder bath method Solder alloy Sn-Ag-Cu (Lead Free Solder) Temperature (270 ± 5) °C Duration of immersion (10±1) s Depth of immersion 10 mm Post-treatment Let sit for (24 ± 2) h at room temperature, then measure.

Table 1: Specifications and Methods

No.	Item	Specification	Test Method															
9	Solderability	Appearance 95% of the terminations is to be soldered evenly and continuously	Pre-heating 80 °C-120 °C,Time: 10-30 s Test Method Solder bath Flux Solution of rosin ethanol Solder alloy Sn-Ag-Cu (Lead Free Solder) Temperature (245 ± 5) °C Duration of immersion (2.0 ± 0.5) s Depth of immersion 10 mm															
10	Substrate bending test	Appearance No defects or abnormalities Cap. Change See Table 1-3	Mounting method Solder the capacitor on the test substrate as shown in Fig 2 Pressurization Method as shown in Fig 3 Flexure 1 mm Holding Time (5 ± 1) s then measure the capacitance   Fig. 2 Fig. 3 (Unit: mm)															
11	Adhesive strength of termination	Appearance No defects or abnormalities	Mounting method Solder the capacitor to the test substrate and apply the normal force F indicated in Fig. 4 Holding Time t = (10 ± 1) s Pushing force 0603: F = 5 N  Fig. 4															
12	Vibration	Appearance No defects or abnormalities Cap. Change See Table 1-3 IR Initial specification DF Initial specification	Mounting method Solder the capacitor on the test substrate Amplitude 1.5 mm Kind of Vibration A simple harmonic motion Frequency 10 Hz-55 Hz-10 Hz Vibration Time 1 min Repeat this for 2 hours each in 3 perpendicular directions X, Y, Z, total 6 hours.															
13	Rapid change of temperature	Appearance No defects or abnormalities Cap. Change See Table 1-3 IR Initial specification DF Initial specification Voltage proof No defects or abnormalities.	Pre-treatment Perform heat treatment at (150 +0/-10) °C for 1 h, then soak at room temperature for (24 ± 2) h, then measure. Mounting method Solder the capacitor on the test substrate The number of cycles 5 cycles Temperature Step <table border="1" data-bbox="1093 1332 1451 1508"> <thead> <tr> <th>Step</th> <th>Temp.(°C)</th> <th>Time (min)</th> </tr> </thead> <tbody> <tr> <td>1</td> <td>-55</td> <td>30 ± 3</td> </tr> <tr> <td>2</td> <td>25</td> <td>2-5</td> </tr> <tr> <td>3</td> <td>85</td> <td>30 ± 3</td> </tr> <tr> <td>4</td> <td>25</td> <td>2-5</td> </tr> </tbody> </table> Post-treatment Let sit for (24 ± 2) h at room temperature, then measure.	Step	Temp.(°C)	Time (min)	1	-55	30 ± 3	2	25	2-5	3	85	30 ± 3	4	25	2-5
Step	Temp.(°C)	Time (min)																
1	-55	30 ± 3																
2	25	2-5																
3	85	30 ± 3																
4	25	2-5																

Table 1: Specifications and Methods

No.	Item	Specification		Test Method	
14	Damp heat, steady state	Appearance	No defects or abnormalities	Pre-treatment	Perform heat treatment at (150 +0/-10) °C for 1 h, then soak at room temperature for (24 ± 2) h, then measure.
		Cap. Change	See Table 1-3	Mounting method	Solder the capacitor on the test substrate
		IR	See Table 1-3	Test Temperature	(40 ± 2) °C
		DF	See Table 1-3	Test Humidity	90%-95% RH
				Test Time	(500 ± 12) h
				Post-treatment	Let sit for (24 ± 2) h at room temperature, then measure.
15	High temperature high humidity (steady)	Appearance	No defects or abnormalities	Pre-treatment	Perform heat treatment at (150 +0/-10) °C for 1 h, then soak at room temperature for (24 ± 2) h, then measure.
		Cap. Change	See Table 1-3	Mounting method	Solder the capacitor on the test substrate
		IR	See Table 1-3	Test Temperature	(40 ± 2) °C
		DF	See Table 1-3	Test Humidity	90%-95% RH
				Test Voltage	1.0 × U _R
				Test Time	(500 ± 12) h
				Charge/discharge curren	≤ 50 mA
				Post-treatment	Perform heat treatment at (150 +0/-10) °C for 1 h, then soak at room temperature for (24 ± 2) h, then measure.
16	Endurance	Appearance	No defects or abnormalities	Pre-treatment	Perform heat treatment at (150 +0/-10) °C for 1 h, then soak at room temperature for (24 ± 2) h, then measure.
		Cap. Change	See Table 1-3	Mounting method	Solder the capacitor on the test substrate
		IR	See Table 1-3	Test Temperature	85 °C ± 3 °C
		DF	See Table 1-3	Test Voltage	See Table 1-3
				Test Time	(1000 ± 12) h
				Charge/discharge curren	≤ 50 mA
				Post-treatment	Perform heat treatment at (150 +0/-10) °C for 1 h, then soak at room temperature for (24 ± 2) h, then measure.

Table 1-2: Electrical tests

Series	Size	Temp. Chara.	UR (DC)	Thickness Code	Cap.	Electrical tests			
						DF [max]	IR [min]	Measurement Frequency	Measurement Voltage [Vrms]
C	0603	X5R	25 V	K	4.7 µF	0.125	50 fi·F	1.0±0.1KHz	1.0±0.2

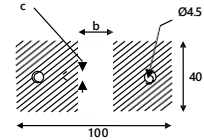
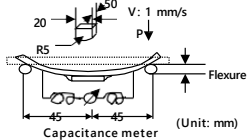
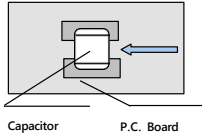
Table 1-3: Cap.¥ D.F¥ IR changes after test

Series	Size	Temp. Chara.	UR (DC)	Thickness Code	Cap.	Resistance to soldering heat	Substrate bending test	Vibration	Rapid change of temperature	Damp heat, steady state			High temperature high humidity (steady)			Endurance			
						Cap. Change [ΔC/C≤±%]	Cap. Change [ΔC/C≤±%]	Cap. Change [ΔC/C≤±%]	Cap. Change [ΔC/C≤±%]	Cap. Change [ΔC/C≤±%]	DF [max]	IR [min]	Cap. Change [ΔC/C≤±%]	DF [max]	IR [min]	Cap. Change [ΔC/C≤±%]	DF [max]	IR [min]	Test Voltage [Vrms]
C	0603	X5R	25 V	K	4.7 µF	15	12.5	7.5	15	12.5	0.2	10 fi·F	12.5	0.2	5 fi·F	12.5	0.2	10 fi·F	1.5 × U _R

4. Packaging, Shipment and storage

4.1 Packaging

4.1.1 packaging type

Reel Packaging (standard carrier tape disc packaging), single disc smallest package see ⑧ Packaging Code

First packaging: Each multi-disc material is packed into a box.

The second packaging: the first packaged packaging box is loaded into the paper packaging box, and the remaining space in the box is filled with light auxiliary materials.

The above packaging forms can also be packaged according to user needs.

4.1.2 Carrier Tape size

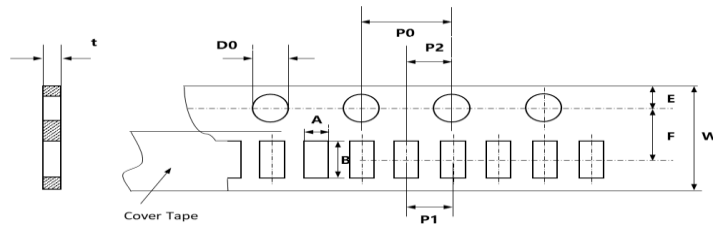

Fig. 5-1 0402 (Paper tape/ 2 mm pitch)

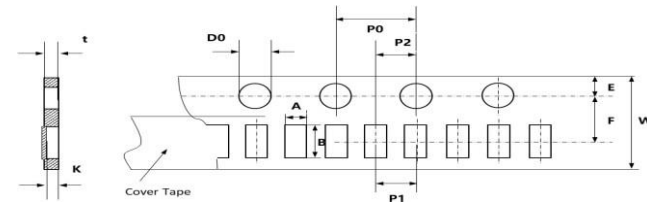

Fig. 5-2 0201 (Paper tape/ 2 mm pitch)

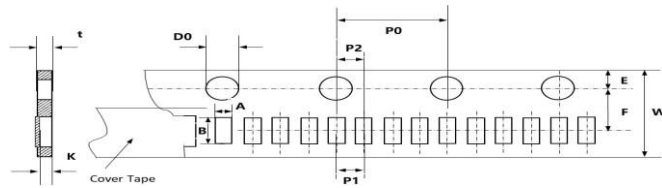

Fig. 5-3 0201 (Paper tape/ 1 mm pitch)

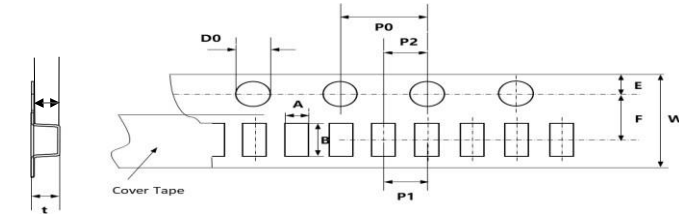

Fig. 5-4 A8A4/0105 (Plastic tape/ 1 mm pitch)

Table 2-1: Carrier size (Size Code:A8A4,0105,0201,0402)

(Unit:mm)

Size Code	Thickness code	Carrier Tape Type	Packaging Code	A	B	F	P1	E	D0	P2	K	W	P0	t
A8A4	1	Plastic	P	0.145 ± 0.007	0.270 ± 0.007	1.80 ± 0.05	1.00 ± 0.05	0.90 ± 0.1	0.80 ± 0.05	1.00 ± 0.05	0.145 ± 0.007	4.00 ± 0.10	2.00 ± 0.1	0.5 max
0105	Z	Paper	T	0.24 ± 0.02	0.45 ± 0.02	3.50 ± 0.05	2.00 ± 0.05	1.75 ± 0.10	1.55 ± 0.05	2.00 ± 0.05	0.24 ± 0.02	8.00 ± 0.10	4.00 ± 0.10	0.5 max
0105	Z	Paper	H	0.24 ± 0.02	0.45 ± 0.02	3.50 ± 0.05	2.00 ± 0.05	1.75 ± 0.10	1.55 ± 0.05	2.00 ± 0.05	0.24 ± 0.02	8.00 ± 0.10	4.00 ± 0.10	0.5 max
0105	Z	Plastic	P	0.24 ± 0.02	0.45 ± 0.02	1.80 ± 0.05	1.00 ± 0.05	0.90 ± 0.10	0.80 ± 0.05	1.00 ± 0.05	0.24 ± 0.02	4.00 ± 0.10	2.00 ± 0.10	0.5 max
0201	A	Paper	T	0.38 ± 0.03	0.68 ± 0.03	3.50 ± 0.05	2.00 ± 0.05	1.75 ± 0.10	1.55 ± 0.05	2.00 ± 0.05	0.36 ± 0.02	8.00 ± 0.10	4.00 ± 0.10	0.5 max
0201	A	Paper	J	0.38 ± 0.03	0.68 ± 0.03	3.50 ± 0.05	2.00 ± 0.05	1.75 ± 0.10	1.55 ± 0.05	2.00 ± 0.05	0.36 ± 0.02	8.00 ± 0.10	4.00 ± 0.10	0.5 max
0201	A	Paper	D	0.38 ± 0.03	0.68 ± 0.03	3.50 ± 0.05	1.00 ± 0.05	1.75 ± 0.10	1.55 ± 0.05	1.00 ± 0.05	0.36 ± 0.02	8.00 ± 0.10	4.00 ± 0.10	0.5 max
0201	A	Paper	A	0.38 ± 0.03	0.68 ± 0.03	3.50 ± 0.05	1.00 ± 0.05	1.75 ± 0.10	1.55 ± 0.05	1.00 ± 0.05	0.36 ± 0.02	8.00 ± 0.10	4.00 ± 0.10	0.5 max
0201	A	Paper	M	0.38 ± 0.03	0.68 ± 0.03	3.50 ± 0.05	2.00 ± 0.05	1.75 ± 0.10	1.55 ± 0.05	2.00 ± 0.05	0.36 ± 0.02	8.00 ± 0.10	4.00 ± 0.10	0.5 max
0201	A	Paper	H	0.38 ± 0.03	0.68 ± 0.03	3.50 ± 0.05	2.00 ± 0.05	1.75 ± 0.10	1.55 ± 0.05	2.00 ± 0.05	0.36 ± 0.02	8.00 ± 0.10	4.00 ± 0.10	0.5 max
0201	A	Paper	L	0.38 ± 0.03	0.68 ± 0.03	3.50 ± 0.05	1.00 ± 0.05	1.75 ± 0.10	1.55 ± 0.05	1.00 ± 0.05	0.36 ± 0.02	8.00 ± 0.10	4.00 ± 0.10	0.5 max
0201	J	Paper	T	0.40 ± 0.04	0.70 ± 0.04	3.50 ± 0.05	2.00 ± 0.05	1.75 ± 0.10	1.55 ± 0.05	2.00 ± 0.05	0.38 ± 0.04	8.00 ± 0.10	4.00 ± 0.10	0.5 max
0201	J	Paper	J	0.40 ± 0.04	0.70 ± 0.04	3.50 ± 0.05	2.00 ± 0.05	1.75 ± 0.10	1.55 ± 0.05	2.00 ± 0.05	0.38 ± 0.04	8.00 ± 0.10	4.00 ± 0.10	0.5 max

Table 2-1: Carrier size (Size Code:A8A4,0105,0201,0402)

(Unit:mm)

Size Code	Thickness code	Carrier Tape Type	Packaging Code	A	B	F	P1	E	D0	P2	K	W	P0	t
0201	J	Paper	D	0.40 \pm 0.04	0.70 \pm 0.04	3.50 \pm 0.05	1.00 \pm 0.05	1.75 \pm 0.10	1.55 \pm 0.05	1.00 \pm 0.05	0.38 \pm 0.04	8.00 \pm 0.10	4.00 \pm 0.10	0.5 max
0201	J	Paper	A	0.40 \pm 0.04	0.70 \pm 0.04	3.50 \pm 0.05	1.00 \pm 0.05	1.75 \pm 0.10	1.55 \pm 0.05	1.00 \pm 0.05	0.38 \pm 0.04	8.00 \pm 0.10	4.00 \pm 0.10	0.5 max
0201	J	Paper	M	0.40 \pm 0.04	0.70 \pm 0.04	3.50 \pm 0.05	2.00 \pm 0.05	1.75 \pm 0.10	1.55 \pm 0.05	2.00 \pm 0.05	0.38 \pm 0.04	8.00 \pm 0.10	4.00 \pm 0.10	0.5 max
0201	J	Paper	H	0.40 \pm 0.04	0.70 \pm 0.04	3.50 \pm 0.05	2.00 \pm 0.05	1.75 \pm 0.10	1.55 \pm 0.05	2.00 \pm 0.05	0.38 \pm 0.04	8.00 \pm 0.10	4.00 \pm 0.10	0.5 max
0201	J	Paper	L	0.40 \pm 0.04	0.70 \pm 0.04	3.50 \pm 0.05	1.00 \pm 0.05	1.75 \pm 0.10	1.55 \pm 0.05	1.00 \pm 0.05	0.38 \pm 0.04	8.00 \pm 0.10	4.00 \pm 0.10	0.5 max
0201	X	Paper	T	0.44 \pm 0.06	0.74 \pm 0.06	3.50 \pm 0.05	2.00 \pm 0.05	1.75 \pm 0.10	1.55 \pm 0.05	2.00 \pm 0.05	0.40 \pm 0.05	8.00 \pm 0.10	4.00 \pm 0.10	0.6 max
0201	X	Paper	J	0.44 \pm 0.06	0.74 \pm 0.06	3.50 \pm 0.05	2.00 \pm 0.05	1.75 \pm 0.10	1.55 \pm 0.05	2.00 \pm 0.05	0.40 \pm 0.05	8.00 \pm 0.10	4.00 \pm 0.10	0.6 max
0201	X	Paper	H	0.44 \pm 0.06	0.74 \pm 0.06	3.50 \pm 0.05	2.00 \pm 0.05	1.75 \pm 0.10	1.55 \pm 0.05	2.00 \pm 0.05	0.40 \pm 0.05	8.00 \pm 0.10	4.00 \pm 0.10	0.6 max
0201	F	Paper	T	0.44 \pm 0.06	0.74 \pm 0.06	3.50 \pm 0.05	2.00 \pm 0.05	1.75 \pm 0.10	1.55 \pm 0.05	2.00 \pm 0.05	0.40 \pm 0.05	8.00 \pm 0.10	4.00 \pm 0.10	0.6 max
0201	B	Paper	H	0.44 \pm 0.06	0.74 \pm 0.06	3.50 \pm 0.05	2.00 \pm 0.05	1.75 \pm 0.10	1.55 \pm 0.05	2.00 \pm 0.05	0.55 \pm 0.05	8.00 \pm 0.10	4.00 \pm 0.10	0.7 max
0201	B	Paper	T	0.44 \pm 0.06	0.74 \pm 0.06	3.50 \pm 0.05	2.00 \pm 0.05	1.75 \pm 0.10	1.55 \pm 0.05	2.00 \pm 0.05	0.55 \pm 0.05	8.00 \pm 0.10	4.00 \pm 0.10	0.7 max
0402	B	Paper	T	0.63 \pm 0.05	1.13 \pm 0.05	3.50 \pm 0.05	2.00 \pm 0.05	1.75 \pm 0.10	1.55 \pm 0.05	2.00 \pm 0.05	/	8.00 \pm 0.10	4.00 \pm 0.10	0.8 max
0402	B	Paper	J	0.63 \pm 0.05	1.13 \pm 0.05	3.50 \pm 0.05	2.00 \pm 0.05	1.75 \pm 0.10	1.55 \pm 0.05	2.00 \pm 0.05	/	8.00 \pm 0.10	4.00 \pm 0.10	0.8 max
0402	N	Paper	T	0.70 \pm 0.10	1.20 \pm 0.10	3.50 \pm 0.05	2.00 \pm 0.05	1.75 \pm 0.10	1.55 \pm 0.05	2.00 \pm 0.05	/	8.00 \pm 0.10	4.00 \pm 0.10	0.8 max
0402	N	Paper	J	0.70 \pm 0.10	1.20 \pm 0.10	3.50 \pm 0.05	2.00 \pm 0.05	1.75 \pm 0.10	1.55 \pm 0.05	2.00 \pm 0.05	/	8.00 \pm 0.10	4.00 \pm 0.10	0.8 max
0402	C	Paper	T	0.75 \pm 0.10	1.30 \pm 0.10	3.50 \pm 0.05	2.00 \pm 0.05	1.75 \pm 0.10	1.55 \pm 0.05	2.00 \pm 0.05	/	8.00 \pm 0.10	4.00 \pm 0.10	0.8 max
0402	C	Paper	J	0.75 \pm 0.10	1.30 \pm 0.10	3.50 \pm 0.05	2.00 \pm 0.05	1.75 \pm 0.10	1.55 \pm 0.05	2.00 \pm 0.05	/	8.00 \pm 0.10	4.00 \pm 0.10	0.8 max
0402	U	Paper	C	0.85 \pm 0.10	1.40 \pm 0.10	3.50 \pm 0.05	2.00 \pm 0.05	1.75 \pm 0.10	1.55 \pm 0.05	2.00 \pm 0.05	/	8.00 \pm 0.10	4.00 \pm 0.10	0.95 max
0402	U	Paper	T	0.85 \pm 0.10	1.40 \pm 0.10	3.50 \pm 0.05	2.00 \pm 0.05	1.75 \pm 0.10	1.55 \pm 0.05	2.00 \pm 0.05	/	8.00 \pm 0.10	4.00 \pm 0.10	0.95 max

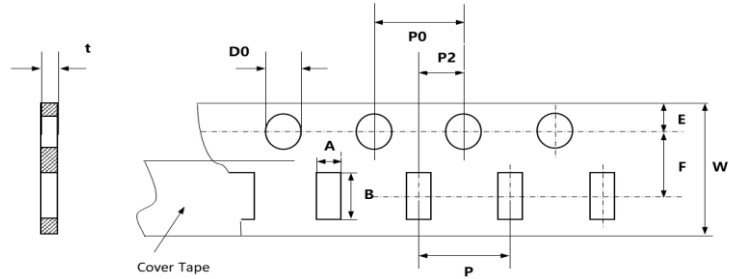

Fig. 5-5 0603, 0805, 1206, 1210 (Paper tape)

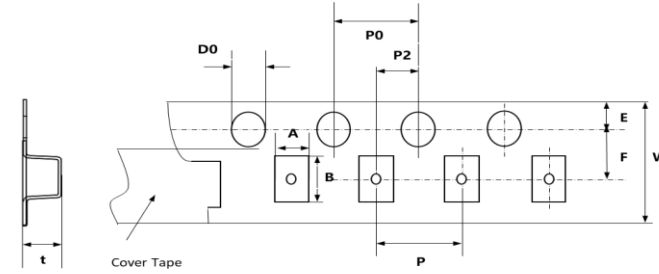

Fig. 5-6 0603,0805,1206,1210 (Plastic tape)

(Unit:mm)

Table 2-2: Carrier size (Size Code:0603, 0805, 1206, 1210)

Size Code	Thickness code	Carrier Tape Type	Packaging Code	A	B	F	P	E	D0	P2	K	W	P0	t
0603	S	Paper	T	1.10 ± 0.10	1.90 ± 0.10	3.50 ± 0.05	4.00 ± 0.10	1.75 ± 0.10	1.55 ± 0.05	2.00 ± 0.05	/	8.00 ± 0.20	4.00 ± 0.10	0.70 max
0603	D	Paper	T	1.00 ± 0.10	1.80 ± 0.10	3.50 ± 0.05	4.00 ± 0.10	1.75 ± 0.10	1.55 ± 0.05	2.00 ± 0.05	/	8.00 ± 0.20	4.00 ± 0.10	1.15 max
0603	D	Paper	A	1.00 ± 0.10	1.80 ± 0.10	3.50 ± 0.05	4.00 ± 0.10	1.75 ± 0.10	1.55 ± 0.05	2.00 ± 0.05	/	8.00 ± 0.20	4.00 ± 0.10	1.15 max
0603	D	Plastic	O	1.00 ± 0.10	1.80 ± 0.10	3.50 ± 0.05	4.00 ± 0.10	1.75 ± 0.10	1.55 ± 0.05	2.00 ± 0.05	/	8.00 ± 0.20	4.00 ± 0.10	1.15 max
0603	D	Paper	W	1.00 ± 0.10	1.80 ± 0.10	3.50 ± 0.05	4.00 ± 0.10	1.75 ± 0.10	1.55 ± 0.05	2.00 ± 0.05	/	8.00 ± 0.20	4.00 ± 0.10	1.15 max
0603	K	Paper	T	1.10 ± 0.10	1.90 ± 0.10	3.50 ± 0.05	4.00 ± 0.10	1.75 ± 0.10	1.55 ± 0.05	2.00 ± 0.05	/	8.00 ± 0.20	4.00 ± 0.10	1.15 max
0603	K	Paper	A	1.10 ± 0.10	1.90 ± 0.10	3.50 ± 0.05	4.00 ± 0.10	1.75 ± 0.10	1.55 ± 0.05	2.00 ± 0.05	/	8.00 ± 0.20	4.00 ± 0.10	1.15 max
0603	K	Plastic	O	1.10 ± 0.10	1.90 ± 0.10	3.50 ± 0.05	4.00 ± 0.10	1.75 ± 0.10	1.55 ± 0.05	2.00 ± 0.05	/	8.00 ± 0.20	4.00 ± 0.10	1.15 max
0603	K	Paper	W	1.10 ± 0.10	1.90 ± 0.10	3.50 ± 0.05	4.00 ± 0.10	1.75 ± 0.10	1.55 ± 0.05	2.00 ± 0.05	/	8.00 ± 0.20	4.00 ± 0.10	1.15 max
0603	K	Plastic	Q	1.10 ± 0.10	1.90 ± 0.10	3.50 ± 0.05	4.00 ± 0.10	1.75 ± 0.10	1.55 ± 0.05	2.00 ± 0.05	/	8.00 ± 0.20	4.00 ± 0.10	1.15 max
0603	K	Plastic	R	1.10 ± 0.10	1.90 ± 0.10	3.50 ± 0.05	4.00 ± 0.10	1.75 ± 0.10	1.55 ± 0.05	2.00 ± 0.05	/	8.00 ± 0.20	4.00 ± 0.10	1.15 max
0603	W	Plastic	R	1.10 ± 0.20	1.90 ± 0.20	3.50 ± 0.05	4.00 ± 0.10	1.75 ± 0.10	1.55 ± 0.05	2.00 ± 0.05	/	8.00 ± 0.20	4.00 ± 0.10	1.35 max
0603	W	Plastic	O	1.10 ± 0.20	1.90 ± 0.20	3.50 ± 0.05	4.00 ± 0.10	1.75 ± 0.10	1.55 ± 0.05	2.00 ± 0.05	/	8.00 ± 0.20	4.00 ± 0.10	1.35 max
0603	W	Plastic	Q	1.10 ± 0.20	1.90 ± 0.20	3.50 ± 0.05	4.00 ± 0.10	1.75 ± 0.10	1.55 ± 0.05	2.00 ± 0.05	/	8.00 ± 0.20	4.00 ± 0.10	1.35 max
0805	C	Paper	T	1.45 ± 0.10	2.20 ± 0.10	3.50 ± 0.05	4.00 ± 0.10	1.75 ± 0.10	1.55 ± 0.05	2.00 ± 0.05	/	8.00 ± 0.20	4.00 ± 0.10	0.9 max
0805	C	Plastic	R	1.45 ± 0.10	2.20 ± 0.10	3.50 ± 0.05	4.00 ± 0.10	1.75 ± 0.10	1.55 ± 0.05	2.00 ± 0.05	/	8.00 ± 0.20	4.00 ± 0.10	0.9 max
0805	K	Paper	T	1.45 ± 0.20	2.20 ± 0.20	3.50 ± 0.05	4.00 ± 0.10	1.75 ± 0.10	1.55 ± 0.05	2.00 ± 0.05	/	8.00 ± 0.20	4.00 ± 0.10	1.15 max
0805	K	Plastic	R	1.45 ± 0.20	2.20 ± 0.20	3.50 ± 0.05	4.00 ± 0.10	1.75 ± 0.10	1.55 ± 0.05	2.00 ± 0.05	/	8.00 ± 0.20	4.00 ± 0.10	1.15 max
0805	K	Plastic	E	1.45 ± 0.20	2.20 ± 0.20	3.50 ± 0.05	4.00 ± 0.10	1.75 ± 0.10	1.55 ± 0.05	2.00 ± 0.05	/	8.00 ± 0.20	4.00 ± 0.10	1.15 max
0805	Y	Paper	T	1.45 ± 0.20	2.20 ± 0.20	3.50 ± 0.05	4.00 ± 0.10	1.75 ± 0.10	1.55 ± 0.05	2.00 ± 0.05	/	8.00 ± 0.20	4.00 ± 0.10	1.15 max
0805	Y	Plastic	E	1.45 ± 0.20	2.20 ± 0.20	3.50 ± 0.05	4.00 ± 0.10	1.75 ± 0.10	1.55 ± 0.05	2.00 ± 0.05	/	8.00 ± 0.20	4.00 ± 0.10	1.15 max
0805	Y	Plastic	P	1.45 ± 0.20	2.20 ± 0.20	3.50 ± 0.05	4.00 ± 0.10	1.75 ± 0.10	1.55 ± 0.05	2.00 ± 0.05	/	8.00 ± 0.20	4.00 ± 0.10	1.15 max
0805	Y	Plastic	R	1.45 ± 0.20	2.20 ± 0.20	3.50 ± 0.05	4.00 ± 0.10	1.75 ± 0.10	1.55 ± 0.05	2.00 ± 0.05	/	8.00 ± 0.20	4.00 ± 0.10	1.15 max
0805	G	Plastic	R	1.45 ± 0.10	2.20 ± 0.10	3.50 ± 0.05	4.00 ± 0.10	1.75 ± 0.10	1.55 ± 0.05	2.00 ± 0.05	/	8.00 ± 0.20	4.00 ± 0.10	1.75 max
0805	G	Plastic	P	1.45 ± 0.10	2.20 ± 0.10	3.50 ± 0.05	4.00 ± 0.10	1.75 ± 0.10	1.55 ± 0.05	2.00 ± 0.05	/	8.00 ± 0.20	4.00 ± 0.10	1.75 max
0805	G	Plastic	O	1.45 ± 0.10	2.20 ± 0.10	3.50 ± 0.05	4.00 ± 0.10	1.75 ± 0.10	1.55 ± 0.05	2.00 ± 0.05	/	8.00 ± 0.20	4.00 ± 0.10	1.75 max
0805	H	Plastic	R	1.45 ± 0.20	2.20 ± 0.20	3.50 ± 0.05	4.00 ± 0.10	1.75 ± 0.10	1.55 ± 0.05	2.00 ± 0.05	/	8.00 ± 0.20	4.00 ± 0.10	2.00 max
0805	H	Plastic	P	1.45 ± 0.20	2.20 ± 0.20	3.50 ± 0.05	4.00 ± 0.10	1.75 ± 0.10	1.55 ± 0.05	2.00 ± 0.05	/	8.00 ± 0.20	4.00 ± 0.10	2.00 max
0805	H	Plastic	O	1.45 ± 0.20	2.20 ± 0.20	3.50 ± 0.05	4.00 ± 0.10	1.75 ± 0.10	1.55 ± 0.05	2.00 ± 0.05	/	8.00 ± 0.20	4.00 ± 0.10	2.00 max
1206	E	Plastic	R	1.80 ± 0.20	3.40 ± 0.20	3.50 ± 0.05	4.00 ± 0.10	1.75 ± 0.10	1.55 ± 0.05	2.00 ± 0.05	/	8.00 ± 0.20	4.00 ± 0.10	1.15 max
1206	E	Plastic	P	1.80 ± 0.20	3.40 ± 0.20	3.50 ± 0.05	4.00 ± 0.10	1.75 ± 0.10	1.55 ± 0.05	2.00 ± 0.05	/	8.00 ± 0.20	4.00 ± 0.10	1.15 max

Table 2-2: Carrier size (Size Code:0603, 0805, 1206, 1210)

(Unit:mm)

Size Code	Thickness code	Carrier Tape Type	Packaging Code	A	B	F	P	E	D0	P2	K	W	P0	t
1206	Y	Plastic	R	1.80 ± 0.20	3.40 ± 0.20	3.50 ± 0.05	4.00 ± 0.10	1.75 ± 0.10	1.55 ± 0.05	2.00 ± 0.05	/	8.00 ± 0.20	4.00 ± 0.10	1.35 max
1206	Y	Plastic	Q	1.80 ± 0.20	3.40 ± 0.20	3.50 ± 0.05	4.00 ± 0.10	1.75 ± 0.10	1.55 ± 0.05	2.00 ± 0.05	/	8.00 ± 0.20	4.00 ± 0.10	1.35 max
1206	O	Plastic	R	1.80 ± 0.20	3.40 ± 0.20	3.50 ± 0.05	4.00 ± 0.10	1.75 ± 0.10	1.55 ± 0.05	2.00 ± 0.05	/	8.00 ± 0.20	4.00 ± 0.10	1.45 max
1206	O	Plastic	P	1.80 ± 0.20	3.40 ± 0.20	3.50 ± 0.05	4.00 ± 0.10	1.75 ± 0.10	1.55 ± 0.05	2.00 ± 0.05	/	8.00 ± 0.20	4.00 ± 0.10	1.45 max
1206	L	Plastic	P	1.80 ± 0.20	3.40 ± 0.20	3.50 ± 0.05	4.00 ± 0.10	1.75 ± 0.10	1.55 ± 0.05	2.00 ± 0.05	/	8.00 ± 0.20	4.00 ± 0.10	2.50 max
1206	L	Plastic	R	1.80 ± 0.20	3.40 ± 0.20	3.50 ± 0.05	4.00 ± 0.10	1.75 ± 0.10	1.55 ± 0.05	2.00 ± 0.05	/	8.00 ± 0.20	4.00 ± 0.10	2.50 max
1206	L	Plastic	E	1.80 ± 0.20	3.40 ± 0.20	3.50 ± 0.05	4.00 ± 0.10	1.75 ± 0.10	1.55 ± 0.05	2.00 ± 0.05	/	8.00 ± 0.20	4.00 ± 0.10	2.50 max
1206	P	Plastic	P	1.90 ± 0.20	3.50 ± 0.20	3.50 ± 0.05	4.00 ± 0.10	1.75 ± 0.10	1.55 ± 0.05	2.00 ± 0.05	/	8.00 ± 0.20	4.00 ± 0.10	2.50 max
1210	L	Plastic	P	2.70 ± 0.20	3.50 ± 0.20	3.50 ± 0.05	4.00 ± 0.10	1.75 ± 0.10	1.55 ± 0.05	2.00 ± 0.05	/	8.00 ± 0.20	4.00 ± 0.10	2.00 max
1210	Q	Plastic	F	2.70 ± 0.20	3.50 ± 0.20	3.50 ± 0.05	4.00 ± 0.10	1.75 ± 0.10	1.55 ± 0.05	2.00 ± 0.05	/	8.00 ± 0.20	4.00 ± 0.10	2.50 max
1210	Q	Plastic	S	2.70 ± 0.20	3.50 ± 0.20	3.50 ± 0.05	4.00 ± 0.10	1.75 ± 0.10	1.55 ± 0.05	2.00 ± 0.05	/	8.00 ± 0.20	4.00 ± 0.10	2.50 max
1210	Q	Plastic	Z	2.70 ± 0.20	3.50 ± 0.20	3.50 ± 0.05	4.00 ± 0.10	1.75 ± 0.10	1.55 ± 0.05	2.00 ± 0.05	/	8.00 ± 0.20	4.00 ± 0.10	2.50 max
1210	R	Plastic	Z	2.70 ± 0.20	3.50 ± 0.30	3.50 ± 0.05	4.00 ± 0.10	1.75 ± 0.10	1.55 ± 0.05	2.00 ± 0.05	/	8.00 ± 0.20	4.00 ± 0.10	3.00 max
1210	R	Plastic	S	2.70 ± 0.20	3.50 ± 0.30	3.50 ± 0.05	4.00 ± 0.10	1.75 ± 0.10	1.55 ± 0.05	2.00 ± 0.05	/	8.00 ± 0.20	4.00 ± 0.10	3.00 max
1210	3	Plastic	Z	2.70 ± 0.20	3.50 ± 0.40	3.50 ± 0.05	4.00 ± 0.10	1.75 ± 0.10	1.55 ± 0.05	2.00 ± 0.05	/	8.00 ± 0.20	4.00 ± 0.10	3.10 max

4.1.3 Disc size

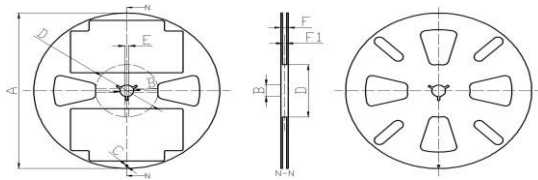

Fig. 6-1 Disc (Width of carrier-4 mm)

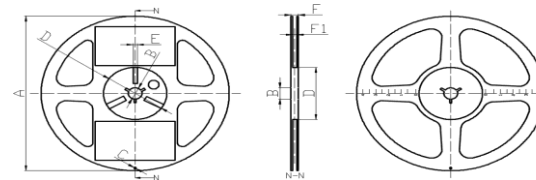

Fig. 6-2 Disc (Width of carrier-8 mm)

Table 3: Disc size

Disc size	Width of carrier	A	B	C	D	E	F	F1	Size Code
7"	8.00 ± 0.10	Φ178 ± 2.0	Φ13 ± 1.0	Φ4.0 ± 0.5	Φ60 ± 2.0	4.0 ± 1.0	11.5 ± 1.0	10.0 ± 2.0	All
13"	8.00 ± 0.10	Φ330 ± 2.0	Φ13 ± 1.0	Φ4.0 ± 0.5	Φ108 ± 2.0	4.0 ± 1.0	13.5 ± 2.0	10.0 ± 2.0	All
7"	4.00 ± 0.10	Φ178 ± 2.0	Φ13 ± 1.0	Φ4.0 ± 0.5	Φ60 ± 2.0	3.5 ± 0.5	7.3 ± 0.5	4.5 ± 1.0	0105/A8A4

4.1.4 Carrier Tape specifications

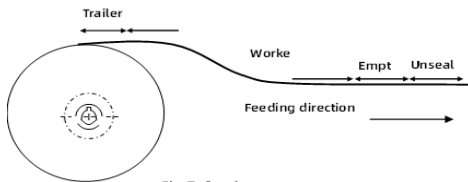

Fig.7 Carrier

Packaging	The minimum length of the reserved spaces		
	Trailer	Empty	Unseal
Carrier	60 mm	200 mm	160 mm

4.1.5 Performance of Carrier Taping

4.1.5.1 Strength of Carrier Tape and Top Cover Tape

a. Carrier Tape

When a tensile force 1.02 kgf is applied in the direction to unreel the tape, the tape shall withstand this force.

b. Top cover Tape

When a tensile force 1.02 kgf is applied to the tape, the tape shall withstand this force.

4.1.5.2 Peeling Strength of Top Cover Tape

Unless otherwise specified, the peeling strength of top cover tape shall be within 10.2 gf to 71.4 gf when the top cover tape is pulled at a speed of 300 mm/min with the angle of 0° to 15° (see Fig. 8).

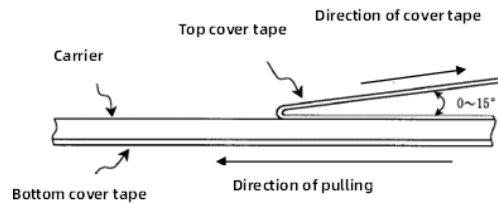

Fig. 8 Cover tape peel-off force

2. Shipment

Transport packaging products to adapt to the modern means of transport, but the product in the process of transport to prevent rain and acid and alkali corrosion, shall not be whipped extrusion casting and gravity.

3. Storage

1. Storage conditions:

The recommended temperature is less than 30 °C.

A temperature is 5 °C to 40 °C and a relative humidity is 20% to 70% as a standard condition.(MSL Level 1)

MLCC may be affected by the storage conditions. Please use them promptly after delivery.

High temperature and humidity conditions and/or prolonged storage may cause deterioration of the packaging materials.

If more than one year has elapsed since delivery, also check the solderability before use.

2. Corrosive gas can react with the termination (external) electrodes or lead wires of capacitors, and result in poor solderability.

Do not store the capacitors in an atmosphere consisting of corrosive gas (e.g.,hydrogen sulfide, sulfur dioxide, chlorine, ammonia gas etc.)

5. MLCC Application of Technical Requirements

5.1 Circuit Design

5.1.1 Operating Temperature

- a. Do not use capacitor above the maximum allowable operating temperature.
- b. Surface temperature including self-heating should be below maximum operating temperature.

5.1.2 Operating Voltage

The operating voltage for capacitors must always be lower than their rated voltage.

5.2 PCB Design

5.2.1 Design of Land-patterns

When the capacitors are mounted on a PCB, the amount of solder at the terminations has a direct effect on the performance of the capacitors.

The greater the amount of solder, the higher the stress on the capacitor. Therefore, when designing land-patterns, it is necessary to consider the appropriate size and configuration of the solder pads.

Size and recommended land dimensions are shown in the following figure and table.

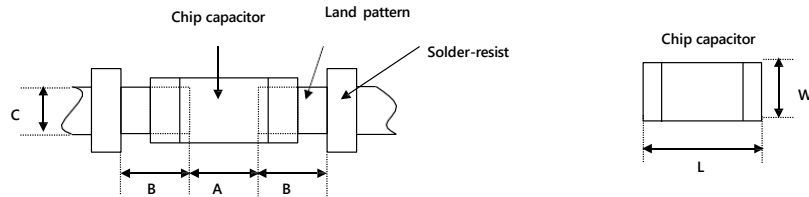

Recommended land dimensions for reflow-soldering

(unit: mm)

Size Code	Length	Width	Tolerance	A	B	C
A8A4	0.25	0.125	all	0.10 - 0.11	0.07 - 0.12	0.125 - 0.145
0105	0.4	0.2	all	0.16 - 0.20	0.12 - 0.18	0.20 - 0.23
0201	0.6	0.3	± 0.03	0.20 - 0.25	0.20 - 0.30	0.20 - 0.35
0201	0.6	0.3	± 0.05	0.20 - 0.25	0.25 - 0.35	0.30 - 0.40
0201	0.6	0.3	± 0.09, ± 0.1	0.23 - 0.30	0.25 - 0.35	0.30 - 0.40
0402	1.0	0.5	± 0.05	0.30 - 0.50	0.35 - 0.45	0.40 - 0.60
0402	1.0	0.5	± 0.15, ± 0.20	0.40 - 0.60	0.40 - 0.50	0.50 - 0.70
0402	1.0	0.5	± 0.30	0.40 - 0.60	0.40 - 0.50	0.50 - 0.80
0603	1.6	0.8	± 0.10	0.60 - 0.80	0.60 - 0.70	0.60 - 0.80
0603	1.6	0.8	± 0.20	0.70 - 0.90	0.70 - 0.80	0.80 - 1.00
0603	1.6	0.8	± 0.25, ± 0.30	0.70 - 0.90	0.70 - 0.90	0.80 - 1.10
0805	2.0	1.25	± 0.10, ± 0.15, ± 0.20	1.00 - 1.40	0.60 - 0.80	1.20 - 1.40
0805	2.0	1.25	± 0.25	1.00 - 1.40	0.70 - 0.90	1.35 - 1.55
1206	3.2	1.6	± 0.15, ± 0.20	1.80 - 2.00	0.90 - 1.20	1.50 - 1.70
1206	3.2	1.6	± 0.30	1.90 - 2.10	1.00 - 1.30	1.60 - 1.90
1210	3.2	2.5	± 0.20	2.00 - 2.40	1.00 - 1.20	2.50 - 2.70
1210	3.2	2.5	± 0.30	2.00 - 2.40	1.10 - 1.30	2.50 - 2.80

5.2.2 Capacitor Layout on PC Board

Mechanical stress varies according to the location of capacitors on PC board. The recommendation for better design is as follows

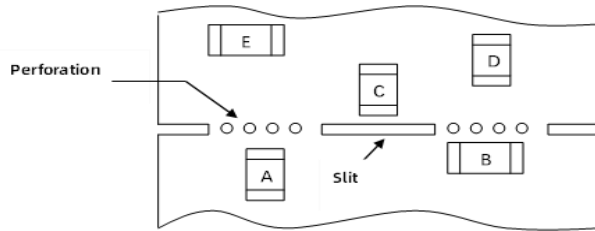

The stress in capacitors is in the following order: $A > B = C > D > E$

Pay attention not to bend or distort the PC board otherwise the capacitor may crack.

Please refer to the following examples of good and bad capacitors layout.

a. Not recommended

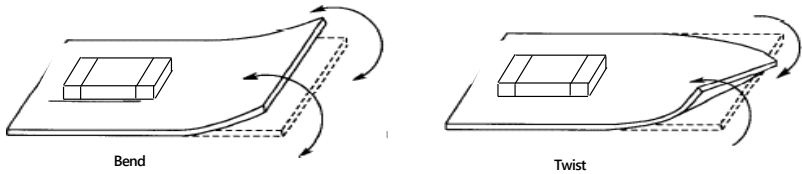

b. Recommended

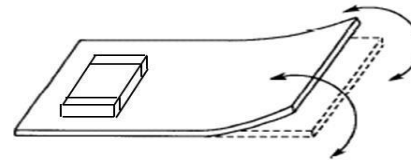

5.2.3 Solder Buildup and Soldering

a. Examples of soldering method not recommended

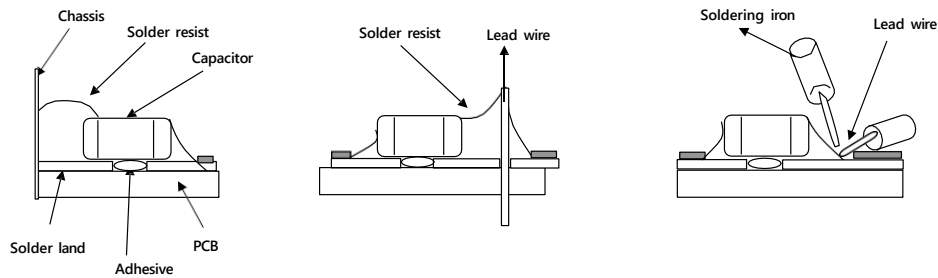

b. Examples of soldering method recommended

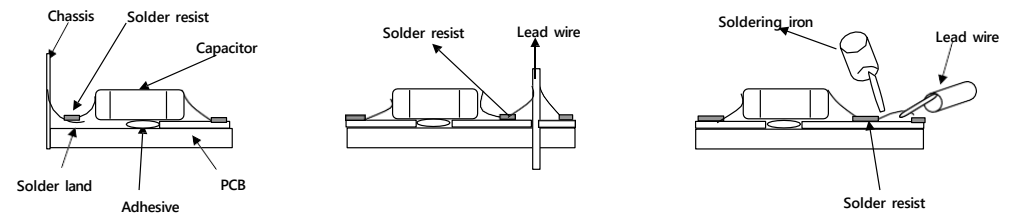

5.3 Consideration for Automatic Placement

If the mounting head is adjusted too low, it may induce excessive stress in the chip capacitor to result in cracking. Please take following precautions

- a. Adjust the bottom dead center of the mounting head to reach on the PC board surface and not press it ;
- b. Adjust the mounting head pressure to be 1N to 3N of static weight ;
- c. To minimize the impact energy from mounting head, it is important to provide support from the bottom side of the PC board.

Please refer to the following samples

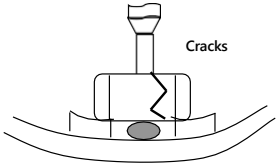
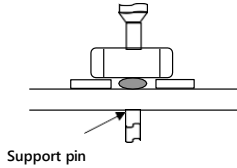
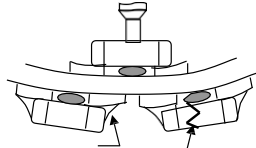
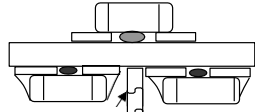
Mounting	Not recommended	Recommended
Singel-sided Mounting	 Cracks	 Support pin
Double-sided Mounting	 Solder peeling Cracks	 Support pin

4. Soldering

1. Flux Selection

- a. It is recommended to use a mildly activated rosin flux (less than 0.1wt% chlorine). Strong flux is not recommended.
- b. Please provide proper amount of flux. Excessive flux must be avoided.
- c. When water-soluble flux is used, enough washing is necessary.

5.4.2 Recommended Soldering Profile

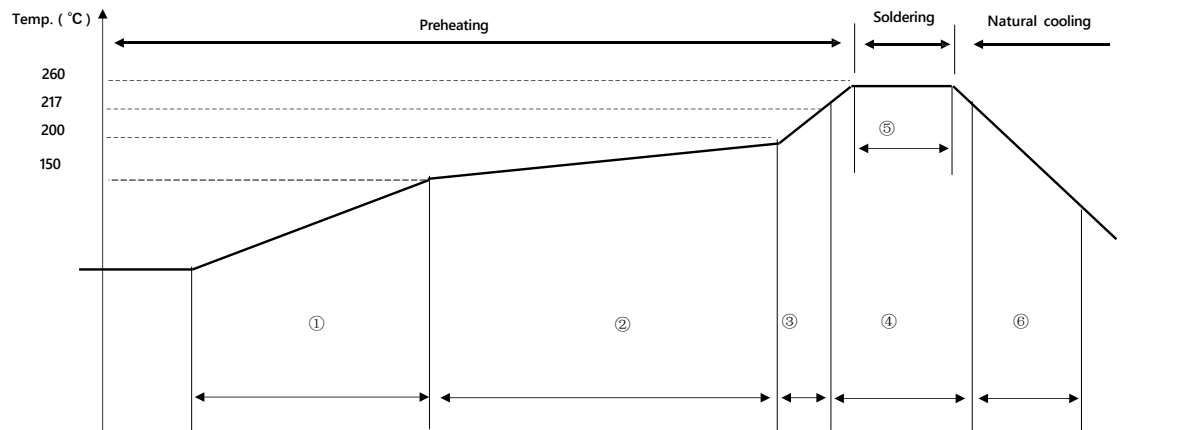

5.4.2.1 Reflow Soldering Condition

NO.	Reflow Soldering zone	Reflow Soldering Condition
①	Preheating 1	≤ 3 °C/s, ≥ 60 s
②	Constant temperature	150°C- 200°C, 60 s-120 s, ≤ 1 °C/s
③	Preheating 1	1-5 °C/s
④	Soldering 1	Above 217 °C, 60-150 s
⑤	Soldering 1	Above 260 °C, over 10 s
⑥	Natural cooling	≤ 6 °C/s

Caution

a.Excessive solder will induce higher tensile force in chip capacitor when temperature changes and result in cracking. Insufficient solder may detach the capacitor from the PC board.

The ideal condition is to have solder mass controlled to 1/2 to 1/3 of the thickness of the capacitors.

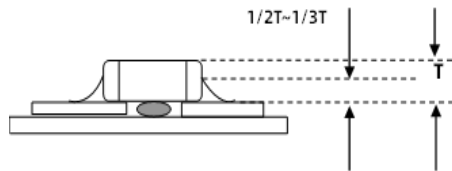

b.Soldering duration should be kept as close to recommended times as possible, because excessive duration can detrimentally affect solderability.

c.The peak temperature of reflow soldering is 245 °C \pm 15 °C.

6. All products in this specification comply with the EU RoHS directive

The EU RoHS Directive refers to the "Directive 2011/65/EU on the Restriction of the Use of Certain Hazardous Substances in Electrical and Electronic Equipment" stipulated by the European Union.

IMPORTANT NOTES AND DISCLAIMER

- **RoHS Compliance:** This product complies with the requirements of EU RoHS Directive (EU) 2015/863 (RoHS 3). The concentration levels of RoHS-restricted substances are below the maximum permitted threshold limits, or the substances are used in applications exempted under the directive. A RoHS Test Report for this product is available through the Download Center.
- **REACH Compliance:** Information regarding REACH Substances of Very High Concern (SVHCs) is available for this product. As the European Chemicals Agency (ECHA) may revise the SVHC list periodically, the latest REACH information and test reports can be obtained from the Download Center.
- **Product Performance:** All product parametric performance data is specified under the electrical characteristics and corresponding test conditions listed herein, unless otherwise noted. Product performance may differ if the device is operated outside the specified conditions.
- **Specifications and Changes:** NextGen Components, Inc. ("*NextGen*") reserves the right to make changes to this document, as well as to its products and specifications, at any time without prior notice. Customers are responsible for obtaining and verifying the most current product information prior to final design, purchase, or use.
- **Warranty and Limitation of Liability:** *NextGen* makes no warranty, representation, or guarantee regarding the suitability of its products for any particular purpose and assumes no liability for application assistance or customer product design. NextGen shall not be responsible for, nor accept liability arising from, the use of its products in unintended, unauthorized, or improper applications. No license, express or implied, is granted under any intellectual property rights of *NextGen*.
- **Restricted Applications:** *NextGen* products are not authorized for use as critical components in life-support devices or systems, or in other safety-critical applications, without express written approval from *NextGen*.
- **Returns Policy:** Customers must obtain a Returned Merchandise Authorization (RMA) number prior to returning any products. Returns must be requested within 30 days from the invoice date and must be in original packaging, unused, and in like-new condition. Products designated as Non-Cancelable / Non-Returnable (NCNR) at the time of quotation or purchase are not eligible for return or refund.